

DEFRO
home

Prestige

FIREPLACES INSERTS
FREESTANDING STOVES

**WARMTH
OF HEART
AND HOME**



The traditions of our family business date back to 1973. We can proudly admit that after nearly half a century of activity, we have developed a certain position as the Polish leader and one of the largest manufacturers of heating devices in Europe. The DEFRO brand stands for reliability and experience in the production of central heating boilers and working with steel elements. It is also the strength of tradition, family values and a staff of over 800 people, who are the heart of the company. Annually, nearly 45,000 devices leave the factory. Modern and reliable devices are delivered to customers. In recent years, the plant has also specialized in the production of steel pressure vessels and recuperators for mechanical ventilation.



DEFRO HOME FIREPLACES



Depending on whether we want to heat only the house or additionally heat potable water, we must choose a device with appropriate power and efficiency, to do this, go to the fireplace lounge, where specialists will advise us on a device tailored to our needs. DEFRO devices are perfect for both systems. A fireplace with hot air distribution is the simplest and, at the same time, the cheapest way to heat the entire house. The principle of its operation is simple, in this case the heated air is distributed to every room through a suitable duct installation located under the ceiling. This system consists of thermally insulated pipes of a large diameter, at the outlets of which special air supply grilles are mounted. In smaller houses that consists of three or four rooms, for the use of this type of heating, gravity distribution, which results from the automatic air circulation, is sufficient. In larger buildings, blowing systems with a built-in fan turn out to be more efficient. The second method of heating the house with wood are fireplaces with a water mantle, i.e. a water heat exchanger that surrounds the combustion chamber. And in this case, the principle of operation is not complicated - water heated in the mantle it is distributed to the installation, which can be wall heaters or underfloor heating. So fireplace with a water mantle connected to the central heating system performs a function similar to a solid fuel fueled device. However, this type of heating requires certain requirements, both technical and safety-related. In order for the operation of this type of system to work flawlessly, services of a certified installer are a must. Thanks to the correct design and connection of the fireplace, we will receive an installation that will provide warmth throughout the house and provide potable hot water. If, on the other hand, you want to install a tasteful stove in your interior that will locally heat your room, choose one of the free-standing devices.



It is worth mentioning that what speaks in favor of heating with a fireplace is the fact that burning wood does not generate high costs and is therefore more economical. However, we must remember that the wood used for burning in the fireplace should have the appropriate humidity. That is why the seasoning process is so important, it should be carried out long enough and in the conditions intended for it. A properly dried wood burns well, gives off a lot of heat and does not smoke. Thus, it does not adversely affect the operation of the entire heating system. When it comes to the calorific value of a wood, it must be remembered that deciduous trees, such as oak or beech, burn best. Lime and birch also burn well, while conifers, due to the resin content, generate a lot of smoke and soot. If you have any doubts, DEFRO specialists will be happy to advise you and answer all your questions.

REMEMBER ABOUT ECOLOGY

From the beginning of 2022, it is extremely important fact that the European Union introduced the Ecodesign directives (also known as Ecodesign). The regulations were created in response to the growing air pollution and concern the efficiency and emissivity of installed heat sources. The point is that from the beginning of this year, only those with Ecodesign can be installed. Fireplaces are covered by these regulations, among others reasons, because in many cases they are used as an independent heat source for heating interiors during transitional periods. For this reason, it is very important to take into account the said certificate when purchasing your dream device.

The second thing to keep in mind is seasonal energy efficiency. This concept describes the efficiency of the fireplace, which is related to its energy efficiency. It is extremely important because the devices with the Ecodesign certificate must meet the required standards both when working with nominal power and with reduced power. Additionally, you should pay attention to the difference between general and seasonal efficiency - it is important that it is as low as possible.

Ecodesign imposes additional tasks on producers. It is mainly about placing the relevant information about the device in both the operating manual and the technical documentation. The customer should carefully check before the purchase whether the characteristics contain information about the Ecodesign certificate. All DEFRO devices meet the most stringent requirements and ensure the highest efficiency.



DURABLE CERAMITON

Feel confidence and safety. The comfort of interior heating is nowadays one of the most desirable values. Go ahead - fall in love with the different types of ceramiton installed in DEFRO devices. Its main advantage is increasing the efficiency of the combustion process, and thus heat accumulation. It is a durable material created especially for our devices, and additionally adds shine and a tasteful look to your fireplace.



STABLE DOOR PROFILE

When choosing a fireplace, it is worth paying attention to the door. They are a movable element of the device and it is definitely important that they are characterized by special durability. For the safe use of the advantages of DEFRO fireplaces, we have created structures based on full door profiles especially for you and your loved ones. As a result, they are resistant to high temperatures and ensure adequate sealing of our fireplaces.

COOL&TOUCH HANDLE

Finishes are what largely determines the luxurious appearance of fireplaces. Details determine their class, and those installed in our devices are not only pleasurable to the eye, but also bring the right mood to the interior in which you decide to install a fireplace. It is also a feast for the spirit and body. The handle is always cool, so you can open your fireplace without worries at any time to add logs. It's all thanks to the perforated structure, which makes the handle cool itself in a natural way.



GUILLOTINE MOUNT

Another detail increasing the prestige of the device, and most importantly the comfort of the user. Inconspicuous at first glance and a small object, it often has a key impact on the final reception and emotions. A handle dedicated to the series of guillotine-opened inserts. It is an invisible, cold handle that allows you to create a natural and uninterrupted view of the fire. After use, the handle can stay in the door or be removed and stored in a specially designed housing. It all depends on you!





DOOR LIFTING UP SYSTEM „PERFECT UP”

The fireplace not only gives a lot of warmth and a sense of security. It also provides blissful peace, and with its brilliance it will soothe even the most battered heart. The sight of our little ones sweetly napping near the fireplace is also a joy to see. Everyone can sleep and relax with our devices. Our designers took care of the noiseless and extremely easy mechanism for opening the door up. In addition, the Perfect UP system, which was developed in the DEFRO laboratory, ensures perfect sealing of the furnace, and thus the highest level of safety. For the sake of your peace and safety.



HIGH QUALITY PAINT

Painting is the production stage where durability planning and low emission of harmful vapors and unpleasant odors are very important. DEFRO HOME fireplace inserts are painted with a paint with a high class of resistance to smoking and mechanical damage. Additionally, after painting the device, the layers of paint are hardened in a proprietary drying room, where special conditions prevail. This process prevents the release of unpleasant odors from the very first lighting.



BLACKLINE GLASS

Care for our users accompanies us at every stage of production. We also want every owner of our fireplaces to feel special, and that his interiors gain a tasteful and unique character. We offer the Black Line solution for our devices. It is glass ceramics with screen printing referring to the latest trends.

1. Air inserts:

DEFRO HOME INTRA series: pg.: 8-23
DEFRO HOME INTRA SLIM series: pg.: 24-31
DEFRO HOME IMPULS series: pg.: 32-35
DEFRO HOME PORTAL series: pg.: 36-37

2. Air inserts with modular construction:

DEFRO HOME INTRA XSM C VER. COMPACT 1: pg.: 38-39

3. Additional equipment for air inserts:

Thermoblock, frames, vents, accesories: pg.: 40-43

4. Inserts with water cartridges:

DEFRO HOME RIVA: pg.: 44-51
DEFRO HOME NAVI: pg.: 52-55

5. Additional equipment for inserts with water cartridges:

Frames and accesories: pg.: 56-57

6. Freestanding wood stoves:

DEFRO HOME ORBIS series: pg.: 58-59
DEFRO HOME SOLUM series: pg.: 60-61
DEFRO HOME DEA, IGNIS and PICO series: pg.: 62-63
DEFRO HOME OVAL, ORTI and ORBIS EXTENTO: pg.: 64-65
DEFRO HOME QUADROOM series: pg.: 66-67
DEFRO HOME VIVA and CUBE MINI series: pg.: 68-69
DEFRO HOME CERES series: pg.: 70-71

7. Freestanding pellet stoves:

DEFRO HOME MYPELL series: pg.: 72-73
DEFRO HOME SLIMPELL i AIRPELL series: pg.: 74-75
DEFRO HOME OMNIPELL i AQUAPELL series: pg.: 76-77

8. Additional equipment for freestanding stoves:

Colors, black ceramiton, wooden finish, silver handle: pg.: 78-81





Air inserts with straight glass opened to the side



DEFRO HOME INTRA SERIES

The DEFRO HOME INTRA ME air fireplace insert was shown on the product visualization.



Technical data

model / variant	XSM	SM	SM	ME	LA
nominal power	8 kW	10 kW	10 kW	13 kW	16 kW
power range	3,2-9,6 kW	4-12 kW	4-12 kW	5,2-15,6 kW	6,4-19,2 kW
energy efficiency class	A	A	A	A+	A
flue size	150 mm	200 mm	200 mm	200 mm	200 mm
efficiency	80,2 %	80,1 %	80,1 %	80,6 %	80,1 %
flue gas temperature	276°C	267°C	267°C	261°C	269°C
maximum log length	350 mm	500 mm	500 mm	700 mm	850 mm
minimum air inlet area	400 cm ²	500 cm ²	500 cm ²	650 cm ²	800 cm ²
minimum air outlet area	560 cm ²	700 cm ²	700 cm ²	910 cm ²	1120 cm ²
weight	-154 kg	-200 kg	-185 kg	-235 kg	-268 kg

Additional equipment

- black ceramiton
- handle on the other side
- black handle
- thermoblock accumulation
- double glass

Dimensions

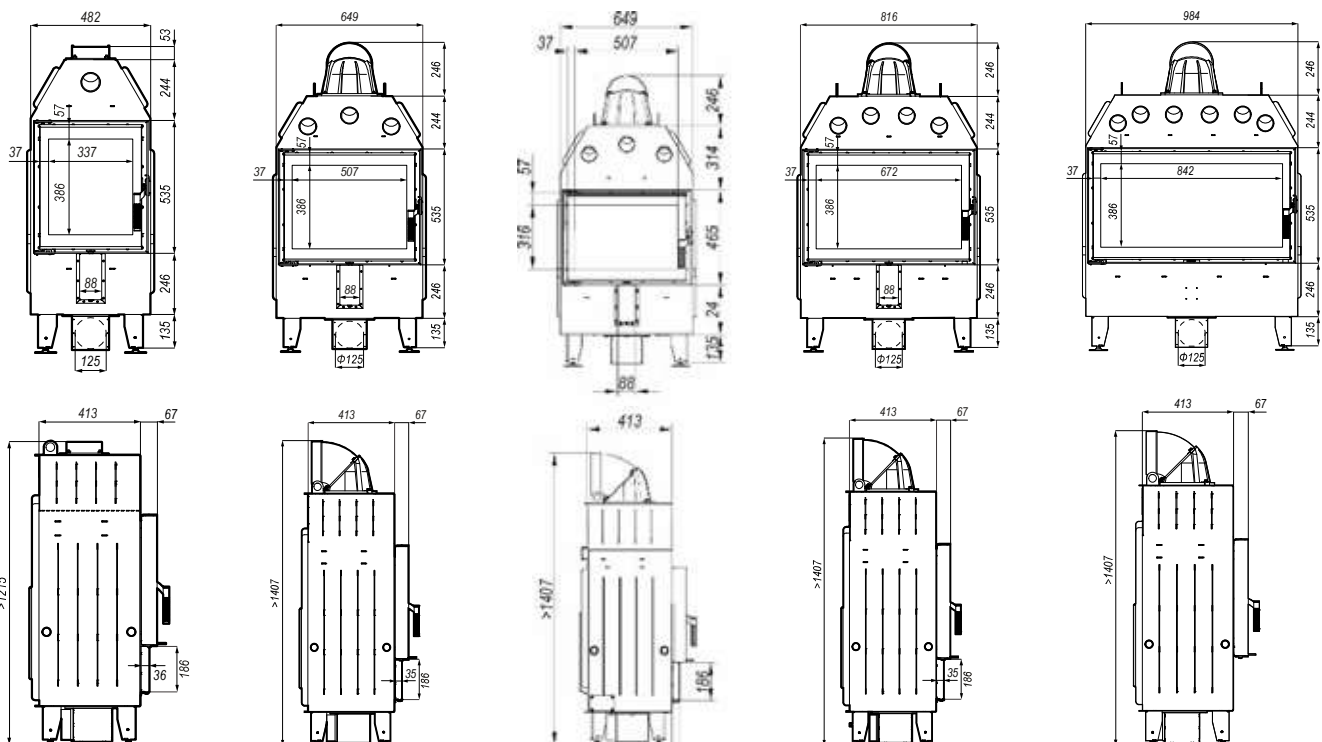

Air inserts with side window opening to the side



DEFRO HOME INTRA SERIES

The DEFRO HOME INTRA ME BL air fireplace insert was shown on the product visualization.



Defro Home Intra
XSM BL/BP MINI



Defro Home Intra
SM BL/BP MINI



Defro Home Intra
SM BL/BP



Defro Home Intra
ME BL/BP



Defro Home Intra
V

Technical data

model / variant	XSM MINI	SM MINI	SM	ME	V
nominal power	8 kW	8 kW	10 kW	13 kW	12,1 kW
power range	3,2-9,6 kW	3,2-9,6 kW	4-12 kW	5,2-15,6 kW	4,8 - 14,4 kW
energy efficiency class	A+	A+	A	A+	A+
flue size	150 mm	150 mm	200 mm	200 mm	178 mm
efficiency	80,9 %	80,9 %	80,1 %	80,6 %	81 %
flue gas temperature	250 °C	250 °C	267 °C	261 °C	227 °C
maximum log length	350 mm	350 mm	500 mm	700 mm	350 mm
minimum air inlet area	400 cm ²	400 cm ²	500 cm ²	650 cm ²	600 cm ²
minimum air outlet area	560 cm ²	560 cm ²	700 cm ²	910 cm ²	840 cm ²
weight	-134 kg	-134 kg	-202 kg	-238 kg	-136 kg

Additional equipment

- black ceramiton
- handle on the other side
- black handle (without Intra V)
- thermoblock accumulation (without Intra V)
- double glass (without Intra V)

Dimensions

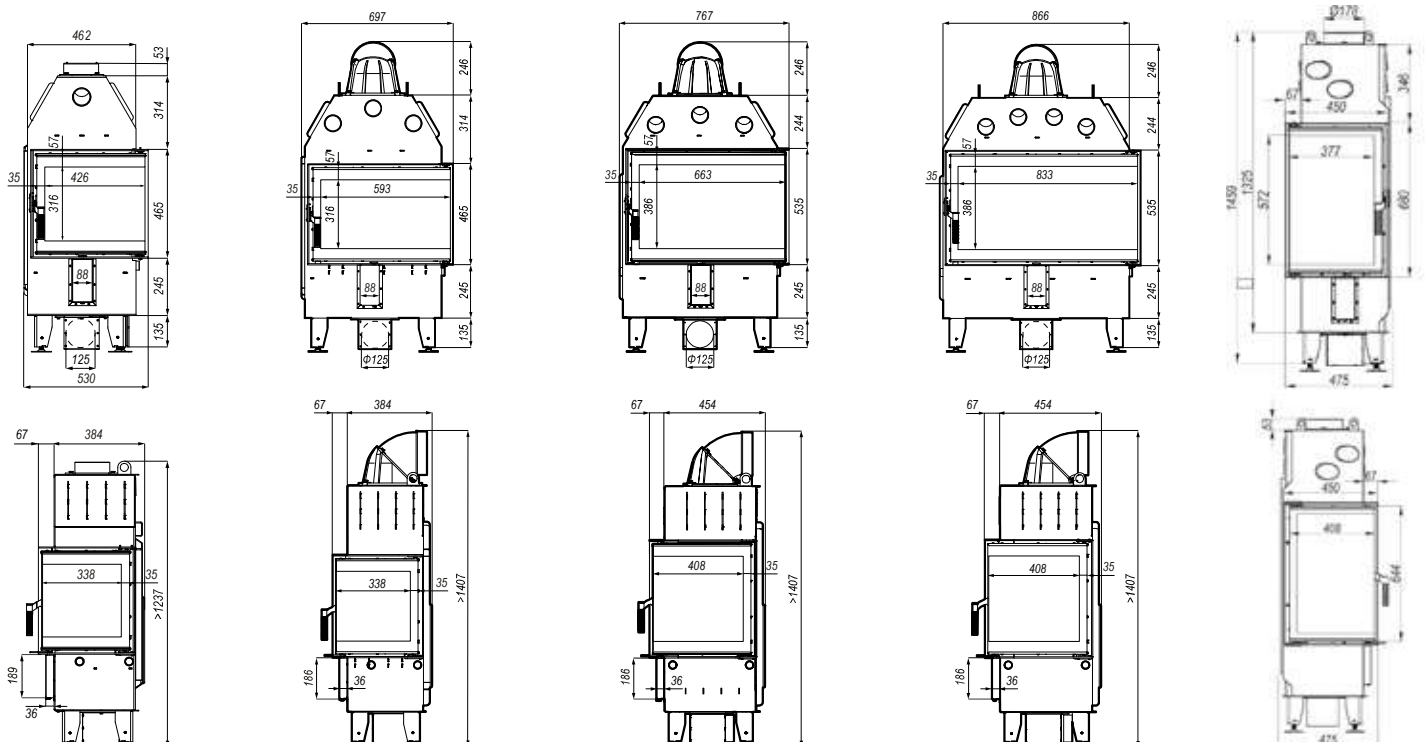

Air inserts with straight glass opened upwards



DEFRO HOME INTRA SERIES

The DEFRO HOME INTRA XLA G air fireplace insert was shown on the product visualization.



Defro Home Intra
XSM G

Defro Home Intra
SM G

Defro Home Intra
ME G

Defro Home Intra
LA G

Defro Home Intra
XLA G

Technical data

model / variant	XSM	SM	ME	LA	XLA
nominal power	8 kW	10 kW	13 kW	16 kW	22 kW
power range	3,2-9,6 kW	4-12 kW	5,2-15,6 kW	6,4-19,2 kW	8,8-26,4 kW
energy efficiency class	A	A	A+	A	A
flue size	150 mm	200 mm	200 mm	200 mm	250 mm
efficiency	80,2 %	80,1 %	80,6 %	80,1 %	80 %
flue gas temperature	276 °C	267 °C	261 °C	269 °C	258 °C
maximum log length	350 mm	500 mm	700 mm	850 mm	850 mm
minimum air inlet area	400 cm ²	500 cm ²	650 cm ²	800 cm ²	1100 cm ²
minimum air outlet area	560 cm ²	700 cm ²	910 cm ²	1120 cm ²	1540 cm ²
weight	-192 kg	-245 kg	-281 kg	-318 kg	-420 kg

Additional equipment

- black ceramiton
- removable handle for quillotines
- black handle
- thermoblock accumulation
- double glass

Dimensions

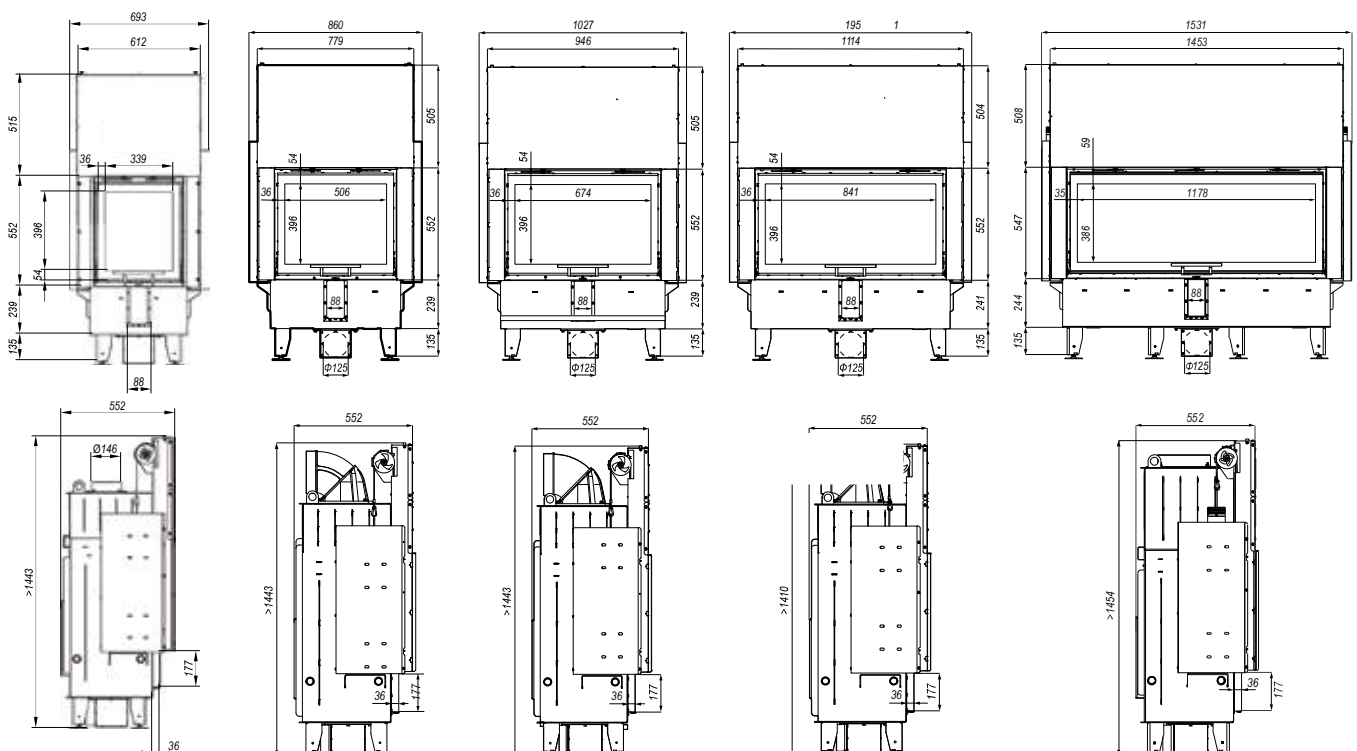

Air inserts with the side window opening upwards



DEFRO HOME INTRA SERIES

The DEFRO HOME INTRA SM BL G air fireplace insert was shown on the product visualization.



Defro Home Intra
XSM BL/BP MINI G



Defro Home Intra
SM BL/BP MINI G



Defro Home Intra
SM BL/BP G



Defro Home Intra
ME BL/BP G



Defro Home Intra
LA BL/BP G

Technical data

model / variant	XSM MINI	SM MINI	SM	ME	LA
nominal power	8 kW	10 kW	10 kW	13 kW	16 kW
power range	3,2-9,6 kW	4-12 kW	4-12 kW	5,2-15,6 kW	6,4-19,2 kW
energy efficiency class	A+	A	A	A+	A
flue size	150 mm	200 mm	200 mm	200 mm	200 mm
efficiency	80,9 %	80,1 %	80,1 %	80,6 %	81,2 %
flue gas temperature	250 °C	267 °C	267 °C	261 °C	264 °C
maximum log length	350 mm	500 mm	500 mm	700 mm	400 mm
minimum air inlet area	400 cm ²	500 cm ²	500 cm ²	650 cm ²	800 cm ²
minimum air outlet area	560 cm ²	700 cm ²	700 cm ²	910 cm ²	1120 cm ²
weight	-195 kg	-235 kg	-264 kg	-306 kg	-336 kg

Additional equipment

- black ceramiton
- removable handle for quillotines
- black handle
- thermoblock accumulation

Dimensions

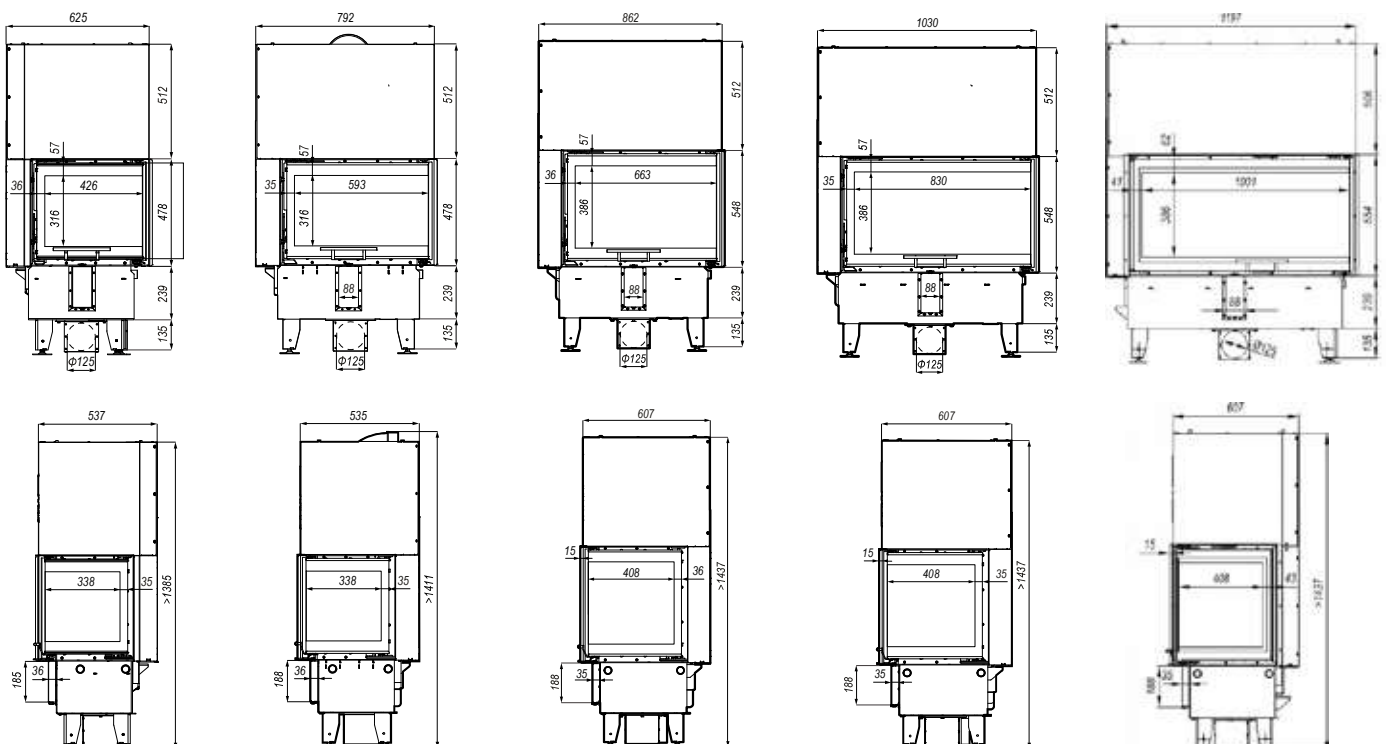

Air inserts with two-sided vision of fire, opened to the side



DEFRO HOME INTRA SERIES

The DEFRO HOME INTRA LA T air fireplace insert was shown on the product visualization.



Defro Home Intra
SM T



Defro Home Intra
ME T



Defro Home Intra
LA T

Technical data

model / variant	SM	ME	LA
nominal power	10 kW	13 kW	16 kW
power range	4-12 kW	5,2-15,6 kW	6,4-19,2 kW
energy efficiency class	A	A+	A
flue size	200 mm	200 mm	200 mm
efficiency	80,1 %	80,6 %	80,1 %
flue gas temperature	267°C	261°C	269°C
maximum log length	500 mm	700 mm	850 mm
minimum air inlet area	500 cm ²	650 cm ²	800 cm ²
minimum air outlet area	700 cm ²	910 cm ²	1120 cm ²
weight	~230 kg	~240 kg	~277 kg

Additional equipment

- black ceramiton
- handle on the other side
- black handle
- thermoblock accumulation
- double glass

Dimensions

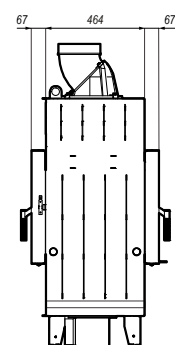
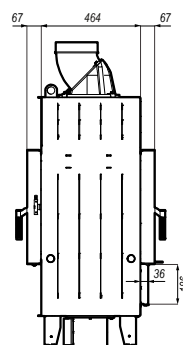
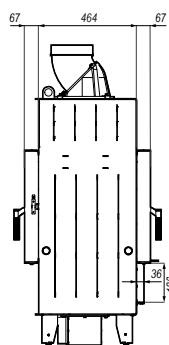
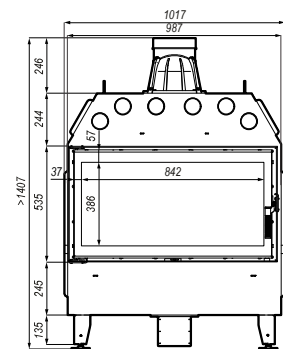
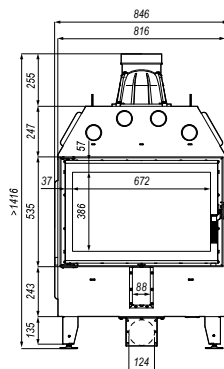
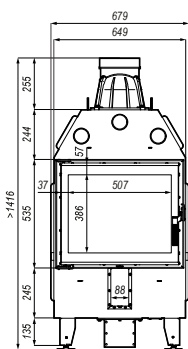

Air inserts with two-sided vision of fire, opening to the top and to the side



DEFRO HOME INTRA SERIES

The DEFRO HOME INTRA MET G air fireplace insert was shown on the product visualization.

 Defro Home Intra
 SMT G

 Defro Home Intra
 MET G

 Defro Home Intra
 LAT G

Technical data

model / variant	SM	ME	LA
nominal power	10 kW	13 kW	16 kW
power range	4-12 kW	5,2-15,6 kW	6,4-19,2 kW
energy efficiency class	A	A+	A
flue size	200 mm	200 mm	200 mm
efficiency	80,1 %	80,6 %	81,2 %
flue gas temperature	267°C	261°C	264°C
maximum log length	500 mm	700 mm	850 mm
minimum air inlet area	500 cm ²	650 cm ²	800 cm ²
minimum air outlet area	700 cm ²	910 cm ²	1120 cm ²
weight	-250 kg	-290 kg	-330 kg

Additional equipment

- czarny ceramiton
- wymiowany uchwyt do gilotyn
- czarna klamka
- podwójna szyba

Dimensions

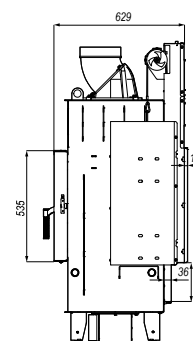
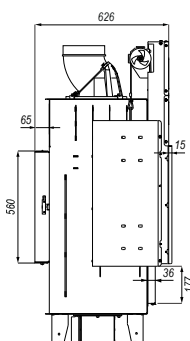
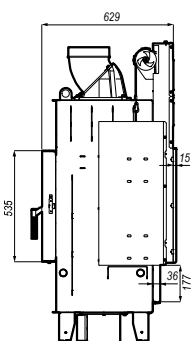
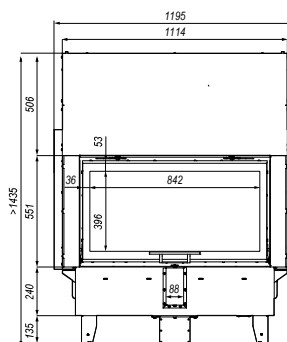
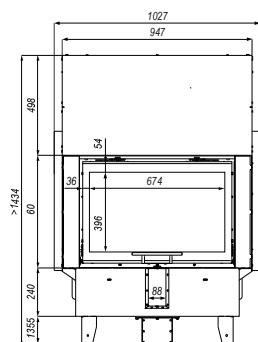
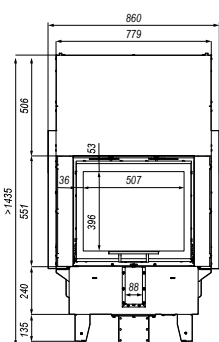

Triple-pane air inserts with side opening



DEFRO HOME INTRA SERIES

The DEFRO HOME INTRA XSM C air fireplace insert was shown on the product visualization.

 Defro Home Intra
 XSM C

 Defro Home Intra
 SM C

Technical data

model / variant	XSM	SM
nominal power	8 kW	10 kW
power range	3,2-9,6 kW	4-12 kW
energy efficiency class	A+	A
flue size	150 mm	200 mm
efficiency	80,2 %	80,1 %
flue gas temperature	276 °C	267 °C
maximum log length	350 mm	500 mm
minimum air inlet area	400 cm ²	500 cm ²
minimum air outlet area	560 cm ²	700 cm ²
weight	~140 kg	~172 kg

Additional equipment

- black ceramiton
- handle on the other side
- thermoblock accumulation

Dimensions

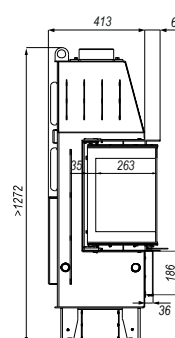
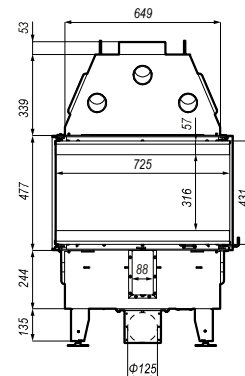
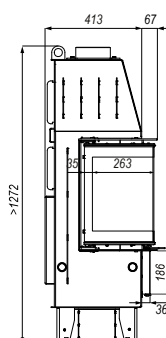
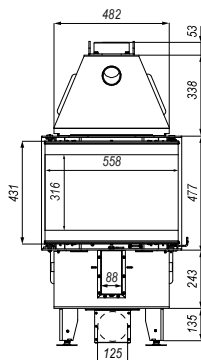

Triple-pane air inserts with upward opening



DEFRO HOME INTRA SERIES

The DEFRO HOME INTRA ME C G air fireplace insert was shown on the product visualization.



Defro Home Intra
XSM CG



Defro Home Intra
SM CG



Defro Home Intra
MEC G



Defro Home Intra
SMUG

Technical data

model / variant	XSM CG	SM CG	MEC G	SMUG
nominal power	8 kW	10 kW	13 kW	16
power range	3,2-9,6 kW	4-12 kW	5,2-15,6 kW	6,4 -19,2
energy efficiency class	A+	A	A+	A+
flue size	150 mm	294 mm	200 mm	200 mm
efficiency	80,5 %	80,8 %	80,6 %	83,3 %
flue gas temperature	237°C	239°C	261°C	276°C
maximum log length	350 mm	500 mm	700 mm	430 mm
minimum air inlet area	400 cm ²	500 cm ²	650 cm ²	800 cm ²
minimum air outlet area	560 cm ²	700 cm ²	910 cm ²	1120 cm ²
weight	~240 kg	~280 kg	~320 kg	~190 kg

Additional equipment

- black ceramiton
- removable handle for quillotines
- black handle

Dimensions

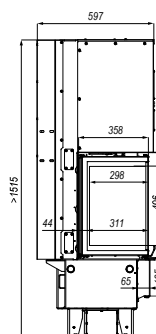
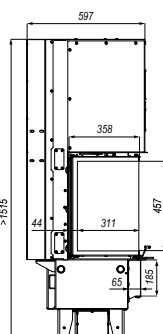
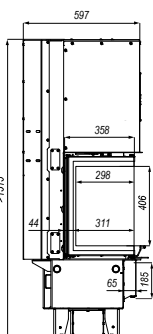
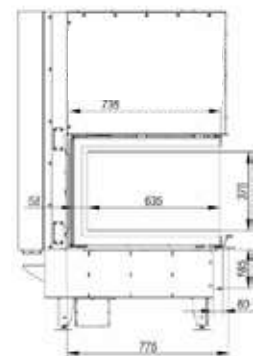
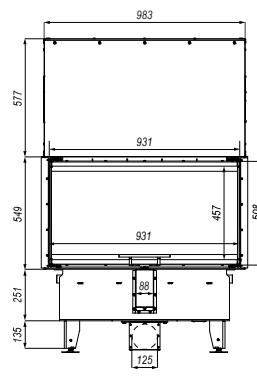
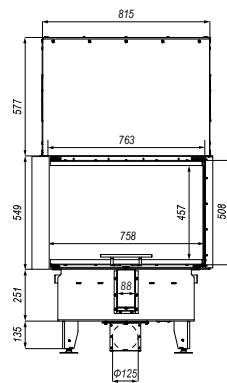
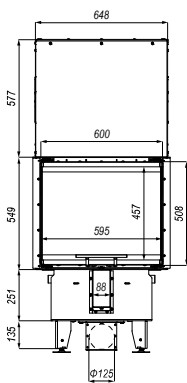

Air inserts with straight glass opened to the side



DEFRO HOME INTRA SLIM SERIES

The DEFRO HOME INTRA ME SLIM air fireplace insert was shown on the product visualization.



Defro Home Intra
SM SLIM



Defro Home Intra
ME SLIM

Technical data

model / variant	SM	ME
nominal power	6 kW	8 kW
power range	2,4-7,2 kW	3,2-9,6 kW
energy efficiency class	A+	A
flue size	200 mm	200 mm
efficiency	82,7 %	80,1 %
flue gas temperature	224 °C	266 °C
maximum log length	500 mm	700 mm
minimum air inlet area	300 cm ²	400 cm ²
minimum air outlet area	420 cm ²	560 cm ²
weight	-156 kg	-181 kg

Additional equipment

- black ceramiton
- black handle
- thermoblock accumulation
- handle on the other side
- double glass

Dimensions

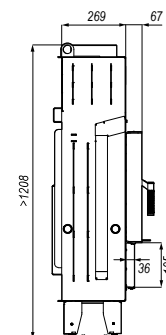
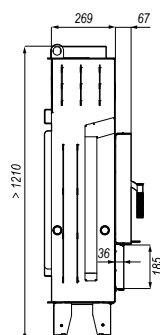
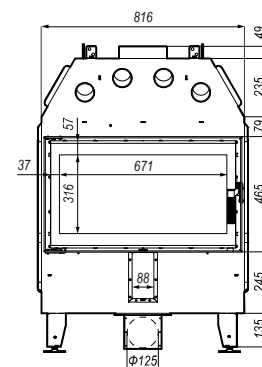
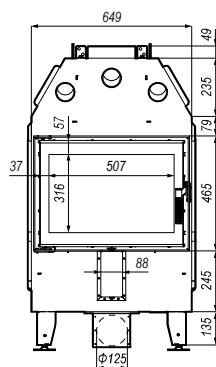

Air inserts with side window opening to the side



DEFRO HOME INTRA SLIM SERIES

The DEFRO HOME INTRA ME BL SLIM air fireplace insert was shown on the product visualization.



Defro Home Intra
SM BL/BP SLIM



Defro Home Intra
ME BL/BP SLIM

Technical data

model / variant	SM	ME
nominal power	6 kW	8 kW
power range	2,4-7,2 kW	3,2-9,6 kW
energy efficiency class	A+	A
flue size	200 mm	200 mm
efficiency	82,7 %	80,1 %
flue gas temperature	224 °C	266 °C
maximum log length	500 mm	700 mm
minimum air inlet area	300 cm ²	400 cm ²
minimum air outlet area	420 cm ²	560 cm ²
weight	-148 kg	-178 kg

Additional equipment

- black ceramiton
- black handle
- handle on the other side
- thermoblock accumulation

Dimensions

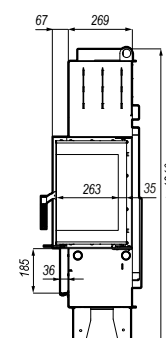
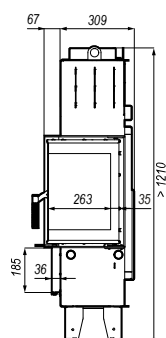
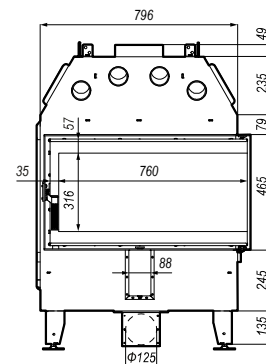
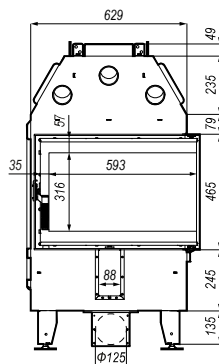

Air inserts with straight glass opened upwards



DEFRO HOME INTRA SLIM SERIES

The DEFRO HOME INTRA SM G SLIM air fireplace insert was shown on the product visualization.



Defro Home Intra
SM SLIM G



Defro Home Intra
ME SLIM G

Technical data

model / variant	SM	ME
nominal power	6 kW	8 kW
power range	2,4-7,2 kW	3,2-9,6 kW
energy efficiency class	A+	A
flue size	200 mm	200 mm
efficiency	82,7 %	80,1 %
flue gas temperature	224 °C	266 °C
maximum log length	500 mm	700 mm
minimum air inlet area	300 cm ²	400 cm ²
minimum air outlet area	420 cm ²	560 cm ²
weight	~209 kg	~240 kg

Additional equipment

- black ceramiton
- black handle
- removable handle for quillotines
- thermoblock accumulation
- double glass

Dimensions

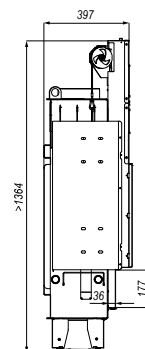
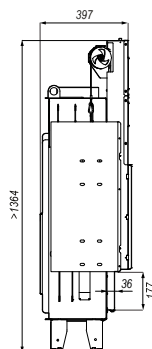
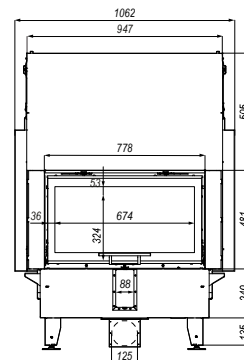
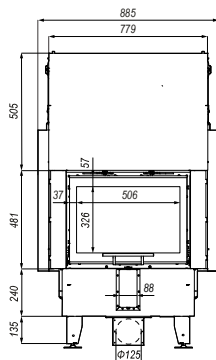

Air inserts with the side window opening upwards



DEFRO HOME INTRA SLIM SERIES

The DEFRO HOME INTRA ME BL G SLIM air fireplace insert was shown on the product visualization.



Defro Home Intra
SM BL / BP SLIM G



Defro Home Intra
ME BL / BP SLIM G

Technical data

model / variant	SM	ME
nominal power	6 kW	8 kW
power range	2,4-7,2 kW	3,2-9,6 kW
energy efficiency class	A+	A
flue size	200 mm	200 mm
efficiency	82,7 %	80,1 %
flue gas temperature	224 °C	266 °C
maximum log length	500 mm	700 mm
minimum air inlet area	300 cm ²	400 cm ²
minimum air outlet area	420 cm ²	560 cm ²
weight	~214 kg	~250 kg

Additional equipment

- black ceramiton
- black handle
- removable handle for quillotines
- thermoblock accumulation

Dimensions

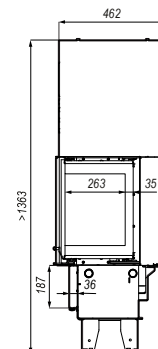
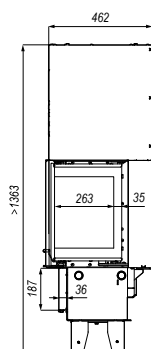
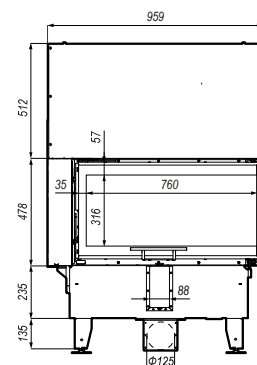
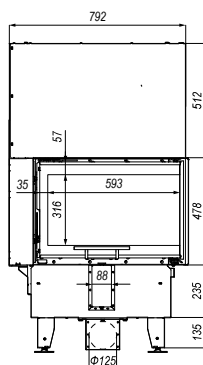

Air inserts with straight glass opened to the side and upwards



DEFRO HOME IMPULS SERIES

The DEFRO HOME IMPULS LA air fireplace insert was shown on the product visualization.



Defro Home Impuls
SM

Defro Home Impuls
SM G

Defro Home Impuls
ME

Defro Home Impuls
ME G

Defro Home Impuls
LA

Technical data

model / variant	SM	SM G	ME	ME G	LA
nominal power	8 kW	8 kW	10 kW	10 kW	12 kW
power range	3,2-9,6 kW	3,2-9,6 kW	4-12 kW	4-12 kW	4,8-14,4 kW
energy efficiency class	A	A	A+	A+	A
flue size	200 mm	200 mm	200 mm	200 mm	200 mm
efficiency	80,2 %	80,2 %	83,8 %	83,8 %	78,4 %
flue gas temperature	282°C	282°C	224°C	224°C	258°C
maximum log length	500 mm	500 mm	700 mm	700 mm	300 mm
minimum air inlet area	400 cm ²	400 cm ²	500 cm ²	500 cm ²	600 cm ²
minimum air outlet area	560 cm ²	560 cm ²	700 cm ²	700 cm ²	840 cm ²
weight	-196 kg	-215 kg	-188 kg	-212kg	-195kg

Additional equipment

- blackline overprint
- handle on the other side

Dimensions

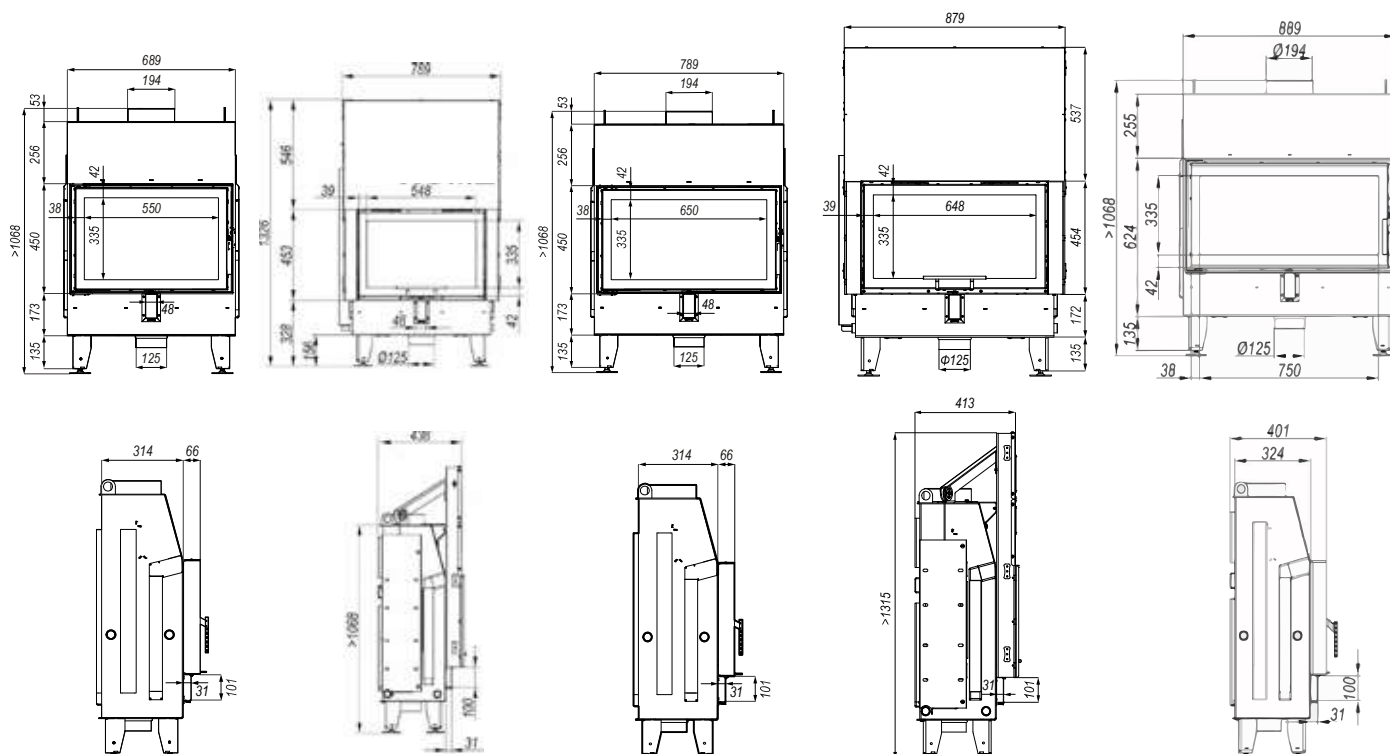

Air inserts with a side window that opens to the side and upwards

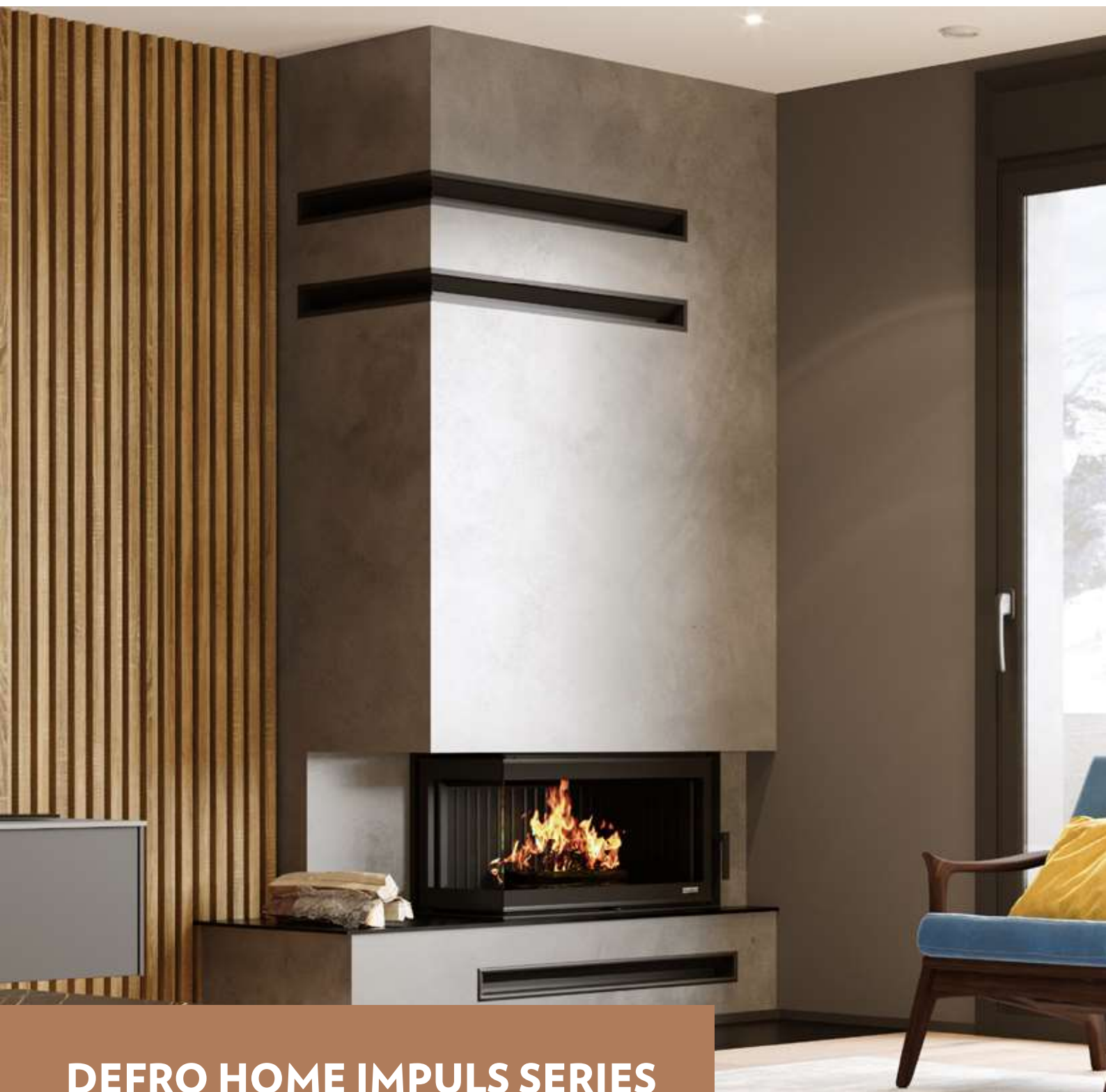

DEFRO HOME IMPULS SERIES

The DEFRO HOME IMPULS LA BL air fireplace insert was shown on the product visualization.



Defro Home Impuls
SM BL/BP

Defro Home Impuls
SM BL/BP G

Defro Home Impuls
ME BL/BP

Defro Home Impuls
ME BL/BP G

Defro Home Impuls
LA BL/BP

Technical data

model / variant	SM	SM G	ME	ME G	LA
nominal power	8 kW	8 kW	10 kW	10 kW	12 kW
power range	3,2-9,6 kW	3,2-9,6 kW	4-12 kW	4-12 kW	4,8-14,4 kW
energy efficiency class	A	A	A+	A+	A
flue size	200 mm	200 mm	200 mm	200 mm	200 mm
efficiency	80,2 %	80,2 %	83,8 %	83,8 %	78,4 %
flue gas temperature	282 °C	282 °C	224 °C	224 °C	258 °C
maximum log length	500 mm	500 mm	700 mm	700 mm	300 mm
minimum air inlet area	400 cm ²	400 cm ²	500 cm ²	500 cm ²	600 cm ²
minimum air outlet area	560 cm ²	560 cm ²	700 cm ²	700 cm ²	840 cm ²
weight	-143 kg	-235 kg	-175 kg	-265 kg	-195kg

Additional equipment

- blackline overprint
- handle on the other side

Dimensions

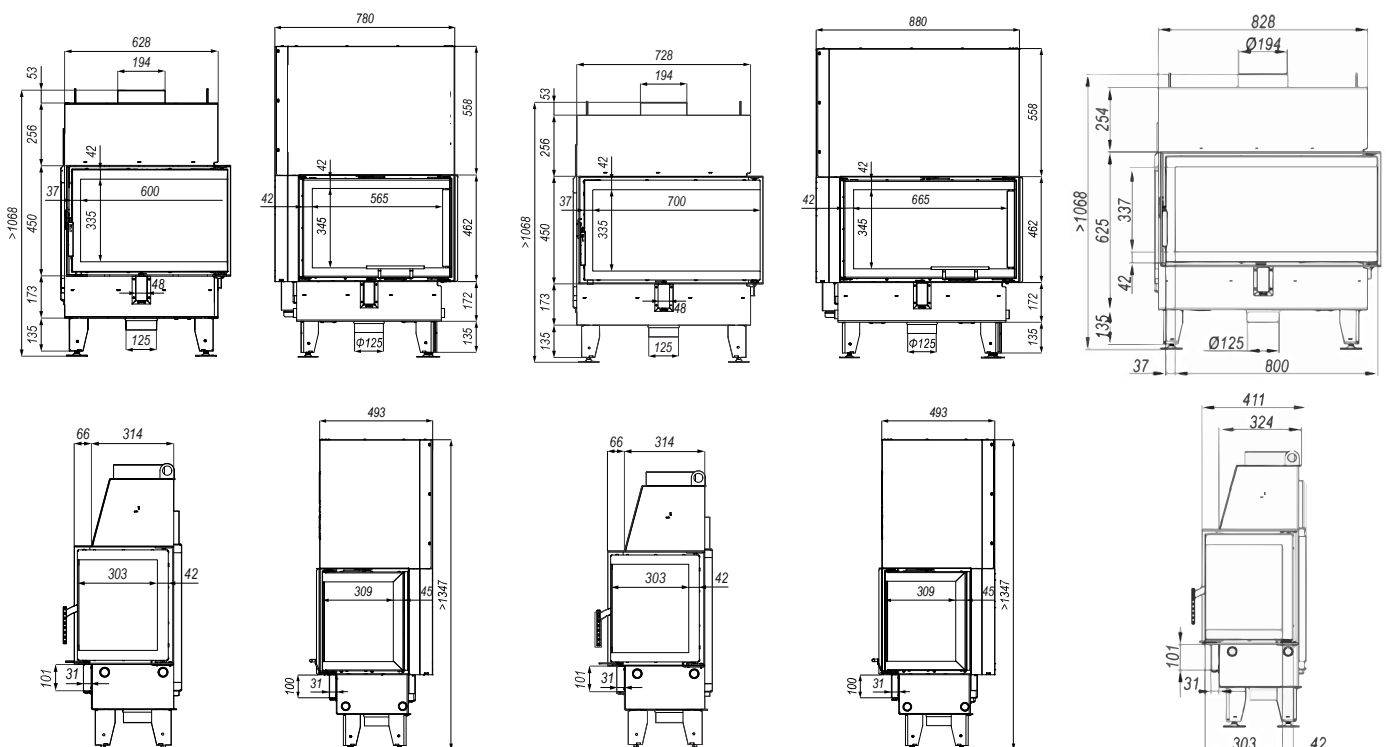

Air inserts with the glass opening to the side or to the top



DEFRO HOME PORTAL SERIES

The DEFRO HOME PORTAL ME air fireplace insert was shown on the product visualization.



Defro Home Portal
ME



Defro Home Portal
ME G

Technical data

model / variant	ME	ME G
nominal power	12 kW	12 kW
power range	4,8-14,4 kW	4,8-14,4 kW
energy efficiency class	A+	A+
flue size	200 mm	200 mm
efficiency	80,5 %	80,5 %
flue gas temperature	248 °C	248 °C
maximum log length	500 mm	500 mm
minimum air inlet area	600 cm ²	600 cm ²
minimum air outlet area	840 cm ²	840 cm ²
weight	~235 kg	~300 kg

Additional equipment

- double glass
- black handle
- handle on the other side
- blackline overprint

Dimensions

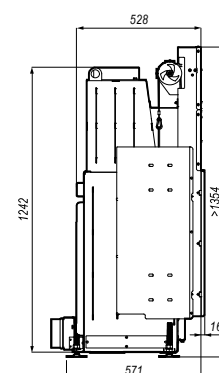
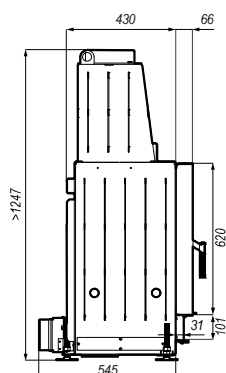
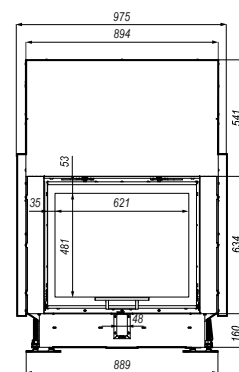
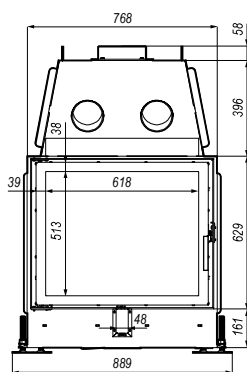



SPECIAL INSERTS SERIES

The DEFRO HOME INTRA XSM C VER. COMPACT 1 air fireplace insert was shown on the product visualization.



Defro Home Intra
XSM C VER. COMPACT 1



Defro Home
Case S

Technical data

model / variant	XSM	CASE S
nominal power	8 kW	8 kW
power range	3,2-9,6 kW	3,2-9,6 kW
energy efficiency class	A+	A+
flue size	150 mm	150 mm
efficiency	80,9 %	82,7 %
flue gas temperature	250 °C	264 °C
maximum log length	350 mm	300 mm
masa	-146 kg	-140 kg

Additional equipment

- black ceramiton
- handle on the other side
- color (red, white, gold, brown, gray)
- double glass

Dimensions

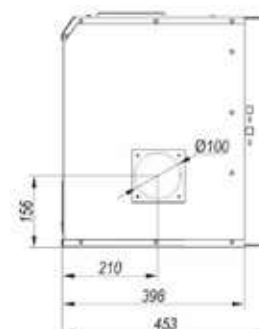
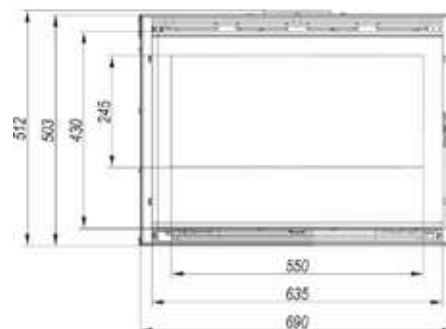
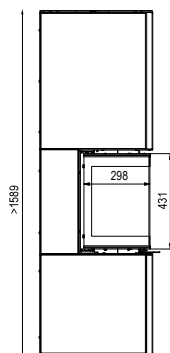
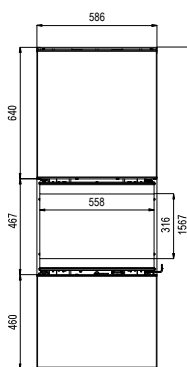

Frames for G and C series inserts

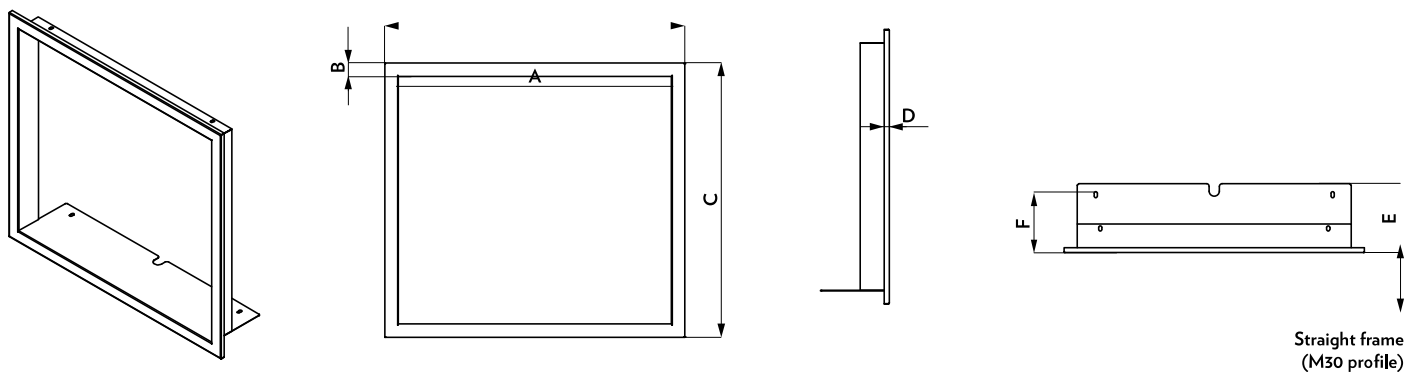

Fireplace specification				Dimensions in mm					
Fireplace name	Flange	Depth	Name	A	B	C	D	E	F
Defro Home Intra SM SLIM G	M30	-	IN_SM_G.MASKOWN.30	661	30	535	10	143	115
Defro Home Intra ME SLIM G	M30	-	IN_ME.G.MASKOWN.30	828	30	535	10	143	115
Defro Home Intra SM G	M30	deep	PR_SM.G.MASKOWN.30.GL	661	30	604	10	151	125
Defro Home Intra ME G	M30	deep	PR_ME.G.MASKOWN.30.GL	828	30	604	10	151	124
Defro Home Intra LA G	M30	deep	PR_LA.G.MASKOWN.30.GL	996	30	604	10	151	124
Defro Home Portal ME G	M30	-	POR_ME.G.MASKOWN.30	775	30	689	10	151	123

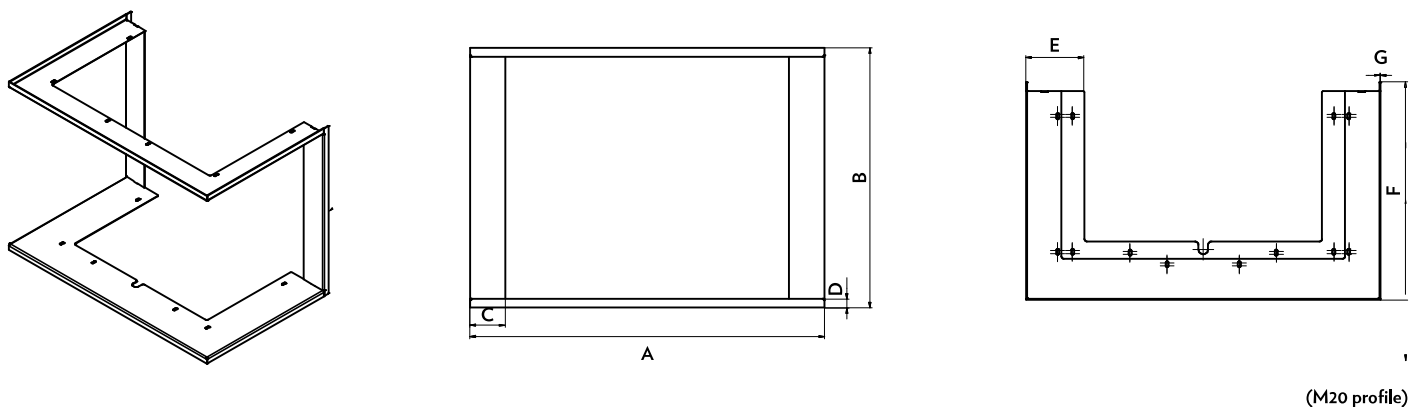

Fireplace specification				Dimensions in mm						
Fireplace name	Flange	Depth	Name	A	B	C	D	E	F	G
Defro Home Intra XSM C G	M20	-	PR_XSM.C.G.MASKOWN.20	803	575	80	20	132	494	2
Defro Home Intra SM C G	M20	-	PR_SM.C.G.MASKOWN.20	971	575	80	20	132	494	2
Defro Home Intra ME C G	M20	-	PR_XSM.C.G.MASKOWN.20	1139	575	80	20	132	494	2
Defro Home Intra XSM C	M20	-	PR_XSM.C.MASKOWN.20	732	501	82	20	82	424	2
Defro Home Intra SM C	M20	-	PR_SM.C.MASKOWN.20	899	501	88	20	88	424	2

We also offer frames for other air inserts. The current offer is available at www.defrohome.pl or at our distributors.

Straight vents - Dimension 80			
Name	Dimension	Index	Active area (cm ²)
DH Luft 200x90 (80)	200x90 (80)	DH/L/200x90(80)	84
DH Luft 480x90 (80)	480x90 (80)	DH/L/480x90(80)	210
DH Luft 650x90 (80)	650x90 (80)	DH/L/650x90(80)	292
DH Luft 810x90 (80)	810x90 (80)	DH/L/810x90(80)	370
DH Luft 980x90 (80)	980x90 (80)	DH/L/980x90(80)	442

Straight vents - Dimension 120			
Name	Dimension	Index	Active area (cm ²)
DH Luft 200x90 (120)	200x90 (120)	DH/L/200x90(120)	92
DH Luft 480x90 (120)	480x90 (120)	DH/L/480x90(120)	321
DH Luft 650x90 (120)	650x90 (120)	DH/L/650x90(120)	322
DH Luft 810x90 (120)	810x90 (120)	DH/L/810x90(120)	408
DH Luft 980x90 (120)	980x90 (120)	DH/L/980x90(120)	499

Corner vents - Dimension 80			
Name	Dimension	Index	Active area (cm ²)
DH Luft corner right 400x740x90 (80)	400x740x90 (80)	DH/L/NP/400x740x90(80)	462
DH Luft corner left 740x400x90 (80)	740x400x90 (80)	DH/L/NL/740x400x90(80)	462
DH Luft corner right 400x910x90 (80)	400x910x90 (80)	DH/L/NP/400x910x90(80)	544
DH Luft corner left 910x400x90 (80)	910x400x90 (80)	DH/L/NL/910x400x90(80)	544
DH Luft corner right 470x740x90 (80)	470x740x90 (80)	DH/L/NP/470x740x90(80)	496
DH Luft corner left 740x470x90 (80)	740x470x90 (80)	DH/L/NL/740x470x90(80)	496
DH Luft corner right 540x810x90 (80)	540x810x90 (80)	DH/L/NP/540x810x90(80)	564
DH Luft corner left 810x540x90 (80)	810x540x90 (80)	DH/L/NL/810x540x90(80)	564
DH Luft corner right 540x980x90 (80)	540x980x90 (80)	DH/L/NP/540x980x90(80)	646
DH Luft corner left 980x540x90 (80)	980x540x90 (80)	DH/L/NL/980x540x90(80)	646

Corner vents - Dimension 120			
Name	Dimension	Index	Active area (cm ²)
DH Luft corner right 400x740x90 (120)	400x740x90 (120)	DH/L/NP/400x740x90(120)	515
DH Luft corner left 740x400x90 (120)	740x400x90 (120)	DH/L/NL/740x400x90(120)	515
DH Luft corner right 400x910x90 (120)	400x910x90 (120)	DH/L/NP/400x910x90(120)	615
DH Luft corner left 910x400x90 (120)	910x400x90 (120)	DH/L/NL/910x400x90(120)	615
DH Luft corner right 470x740x90 (120)	470x740x90 (120)	DH/L/NP/470x740x90(120)	556
DH Luft corner left 740x470x90 (120)	740x470x90 (120)	DH/L/NL/740x470x90(120)	556
DH Luft corner right 540x810x90 (120)	540x810x90 (120)	DH/L/NP/540x810x90(120)	638
DH Luft corner left 810x540x90 (120)	810x540x90 (120)	DH/L/NL/810x540x90(120)	638
DH Luft corner right 540x980x90 (120)	540x980x90 (120)	DH/L/NP/540x980x90(120)	737
DH Luft corner left 980x540x90 (120)	980x540x90 (120)	DH/L/NL/980x540x90(120)	737

Suggested values or active area on inlet and outlet			
Insert name	Power in kW	Minimum air inlet area in cm ²	Minimum air outlet area in cm ²
Defro Home Intra XSM	8	400	560
Defro Home Intra SM / SM G / SM T / SM T G	10	500	700
Defro Home Intra ME / ME G / ME T / ME T G	13	650	910
Defro Home Intra LA / LA G / LA T / LA T G	16	800	1120
Defro Home Intra XSM BL / BP MINI	8	400	560
Defro Home Intra SM BL / BP MINI	10	500	700
Defro Home Intra SM BL / BP	10	500	700
Defro Home Intra ME BL / BP	13	650	910
Defro Home Intra XSM BL / BP MINI G	8	400	560
Defro Home Intra SM BL / BP MINI G	10	500	700
Defro Home Intra SM BL / BP G	10	500	700
Defro Home Intra ME BL / BP G	13	650	910
Defro Home Intra SM C	10	500	700
Defro Home Intra XSM C G	8	400	560
Defro Home Intra SM C G	10	500	700
Defro Home Intra ME C G	13	650	910
Defro Home Intra SM SLIM / SM SLIM G	6	300	420
Defro Home Intra ME SLIM / ME SLIM G	8	400	560
Defro Home Intra SM BL SLIM / BP SLIM	6	300	420
Defro Home Intra ME BL SLIM / BP SLIM	8	400	560
Defro Home Intra SM BL G SLIM / BP G SLIM	6	300	420
Defro Home Intra ME BL G SLIM / BP G SLIM	8	400	560
Defro Home Impuls SM / SM G	8	400	560
Defro Home Impuls ME / ME G	10	500	700
Defro Home Impuls SM BL / BP	8	400	560
Defro Home Impuls ME BL / BP	10	500	700
Defro Home Impuls SM BL / BP G	8	400	560
Defro Home Impuls ME BL / BP G	10	500	700
Defro Home Portal ME / ME G	12	600	840

Thermoblock accumulation

We offer a proprietary THERMOBLOCK solution for heat storage, for all customers wishing to maximize heat recovery from their fireplace. New users of the fireplace allow enjoying environmental friendly heating source emitting natural and healthy heat by radiation.

The material of THERMOBLOCK ensures longterm operation and optimizes the power of the fireplace insert. Developed system of accumulation kits and covers allows customizing THERMOBLOCK to suit the needs of all interiors.

The most important features:

- maximized heat recovery from flue gas,
- the proprietary composition of THERMOBLOCK chamotte mix (transfer of stored heat also when the combustion in the insert is finished),
- patented essence of accumulation with perfect parameters of heat conductivity,
- does not raise dust, does not emit any odours and harmful substances,
- possibility of selection of the suitable amount of covers acc. to customer's requirements,
- assistance for optimisation of power and efficiency of fireplace,
- insert ideally suited covers, does not require processing,
- increases thermal capacity of the fireplace,
- maximizes heat recovery from fireplace insert by convection method.



Model / Number of suggested kits	Number of suggested rear kits	Number of suggested side kits
Defro Home Intra XSM	1	2
Defro Home Intra SM	2	2
Defro Home Intra ME	2	2
Defro Home Intra LA	3	2
Defro Home Intra XSM BP/BL MINI	1	1
Defro Home Intra SM BP/BL MINI	2	1
Defro Home Intra SM BP/BL	2	1
Defro Home Intra ME BP/BL	2	1
Defro Home Intra SM G	1	-
Defro Home Intra ME G	2	-
Defro Home Intra LA G	3	-
Defro Home Intra XLA G	4	-
Defro Home Intra XSM BP/BL MINI G	-	-
Defro Home Intra SM BP/BL MINI G	1	-
Defro Home Intra SM BP/BL G	1	-
Defro Home Intra ME BP/BL G	1	-
Defro Home Intra SM T	-	2
Defro Home Intra ME T	-	2
Defro Home Intra LA T	-	2
Defro Home Intra XSM C	1	-
Defro Home Intra SM C	2	-
Defro Home Intra SM SLIM	2	2
Defro Home Intra ME SLIM	2	2
Defro Home Intra SM BP/BL SLIM	1	1
Defro Home Intra ME BP/BL SLIM	2	1
Defro Home Intra SM BP/BL SLIM G	1	-
Defro Home Intra ME BP/BL SLIM G	1	-
Defro Home Intra SM SLIM G	2	-
Defro Home Intra ME SLIM G	2	-

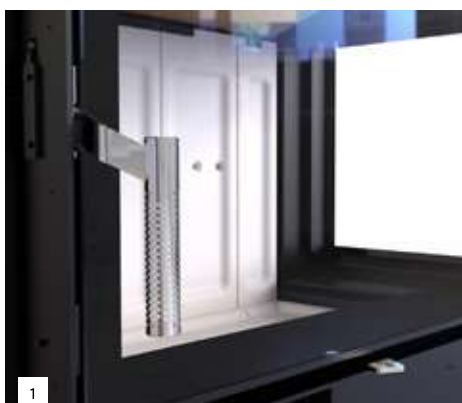

Model / Equipment availability	1. Sitodruk blackline	2. Black handle	3. Black ceramiton	4. Double glass	5. Handle on the other side	6. Removable handle for guillotines	7. Removable handle for guillotines - separate purchase
Defro Home Intra XSM	standard	✓	✓	✓	✓	-	-
Defro Home Intra SM / SM G	standard	✓	✓	✓	✓	✓	✓
Defro Home Intra ME / ME G	standard	✓	✓	✓	✓	✓	✓
Defro Home Intra LA / LA G	standard	✓	✓	✓	✓	-	-
Defro Home Intra XLA G	standard	✓	✓	-	-	✓	✓
Defro Home Intra XSM BL/BP MINI	standard	✓	✓	-	✓	-	-
Defro Home Intra SM BL / BP MINI	standard	✓	✓	-	✓	-	-
Defro Home Intra SM BL /BP	standard	✓	✓	-	✓	-	-
Defro Home Intra ME BL /BP	standard	✓	✓	-	✓	-	-
Defro Home Intra XSM BL/BP MINI G	standard	✓	✓	-	-	✓	✓
Defro Home Intra SM BL / BP G MINI	standard	✓	✓	-	✓	✓	✓
Defro Home Intra SM BL /BP G	standard	✓	✓	-	✓	✓	✓
Defro Home Intra ME BL / BP G	standard	✓	✓	-	-	-	-
Defro Home Intra XSM C	standard	-	✓	-	✓	-	-
Defro Home Intra SM C	standard	✓	✓	-	✓	-	-
Defro Home Intra XSM C G	standard	✓	✓	-	-	✓	✓
Defro Home Intra SM C G	standard	✓	✓	-	-	✓	✓
Defro Home Intra ME C G	standard	✓	✓	-	-	✓	✓
Defro Home Intra ME C G	standard	✓	✓	-	-	✓	✓
Defro Home Intra SM T	standard	✓	✓	✓	✓	-	-
Defro Home Intra ME T	standard	✓	✓	✓	✓	-	-
Defro Home Intra LA T	standard	✓	✓	✓	✓	-	-
Defro Home Intra SM T G	standard	✓	✓	✓	-	✓	✓
Defro Home Intra ME T G	standard	✓	✓	✓	-	✓	✓
Defro Home Intra LA T G	standard	✓	✓	✓	-	✓	✓
Defro Home Intra XSM C G ver. COMPACT 1	standard	-	-	-	-	-	-
Defro Home Intra SM SLIM / SM SLIM G	standard	✓	✓	✓	✓	✓	✓
Defro Home Intra ME SLIM /ME SLIM G	standard	✓	✓	✓	✓	✓	✓
Defro Home Intra SM BL SLIM /BP SLIM	standard	✓	✓	-	✓	-	-
Defro Home Intra SM BL G/ BP SLIM G	standard	✓	✓	-	-	✓	✓
Defro Home Intra ME BL SLIM /BP SLIM	standard	✓	✓	-	✓	-	-
Defro Home Intra ME BL SLIM G / BP SLIM G	standard	✓	✓	-	-	✓	✓
Defro Home Impuls SM	✓	✓	-	-	✓	-	-
Defro Home Impuls ME	✓	-	-	-	✓	-	-
Defro Home Impuls SM BL /BP	✓	-	-	-	✓	-	-
Defro Home Impuls ME BL /BP	✓	-	-	-	✓	-	-
Defro Home Portal ME	-	✓	-	✓	✓	-	-

Inserts with a water cartridge with a straight glass opened to the side



DEFRO HOME RIVA SERIES

The product visualization shows a fireplace insert with a water cartridge DEFRO HOME RIVA SM SHORT.



Defro Home Riva
SM SHORT



Defro Home Riva
ME SHORT



Defro Home Riva
LA SHORT

Technical data

model / variant	SM	ME	LA
nominal power	16 kW	19 kW	22 kW
power range	6,4-19,2 kW	7,6-22,8 kW	8,8-26,4 kW
thermal power of water cycle	8 kW	9 kW	12 kW
energy efficiency class	A+	A+	A
flue size	200 mm	200 mm	200 mm
efficiency	88 %	81,1 %	80,1 %
flue gas temperature	192°C	274°C	289°C
maximum log length	500 mm	700 mm	850 mm
weight	~308 kg	~351 kg	~413 kg

Additional equipment

- black ceramiton
- handle on the other side
- black handle
- double glass

Dimensions

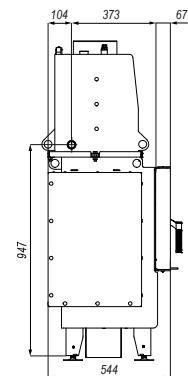
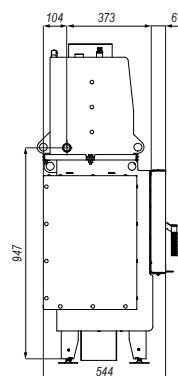
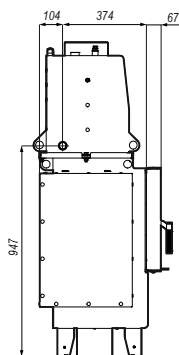
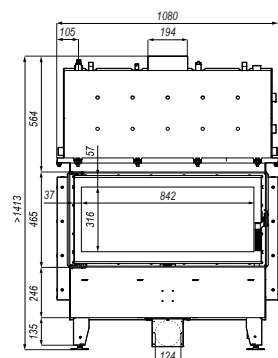
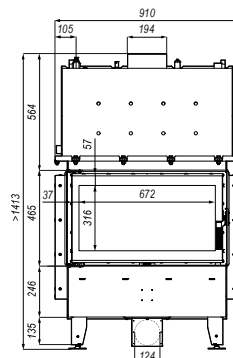
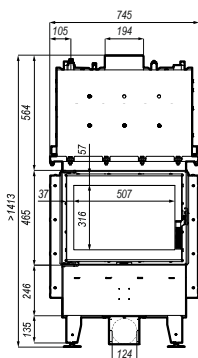

Inserts with a water cartridge with the side window opening to the side



DEFRO HOME RIVA SERIES

The product visualization shows a fireplace insert with a water cartridge DEFRO HOME RIVA ME BL SHORT.

 Defro Home Riva
 SM BP / BL SHORT

 Defro Home Riva
 ME BP / BL SHORT

Technical data

model / variant	SM	ME
nominal power	16 kW	19 kW
power range	6,4-19,2 kW	7,6-22,8 kW
thermal power of water cycle	8 kW	9 kW
energy efficiency class	A+	A+
flue size	200 mm	200 mm
efficiency	88 %	81,1 %
flue gas temperature	192 °C	274 °C
maximum log length	500 mm	700 mm
weight	~318 kg	~354 kg

Additional equipment

- black ceramiton
- black handle
- handle on the other side

Dimensions

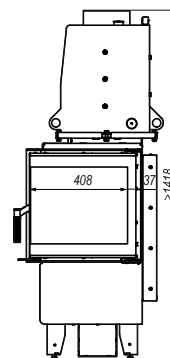
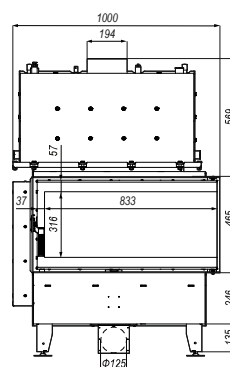
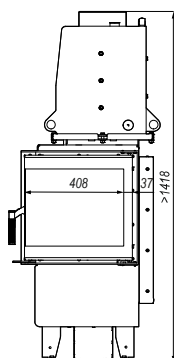
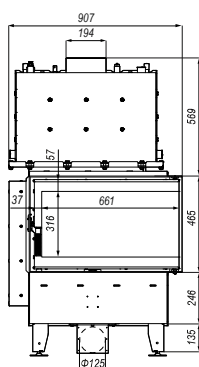

Inserts with a water cartridge with a straight glass opening upwards



DEFRO HOME RIVA SERIES

The product visualization shows a fireplace insert with a water cartridge DEFRO HOME RIVA LA G SHORT.



Defro Home Riva
SM G SHORT



Defro Home Riva
ME G SHORT



Defro Home Riva
LA G SHORT

Technical data

model / variant	SM	ME	LA
nominal power	16 kW	19 kW	22 kW
power range	6,4-19,2 kW	7,6-22,8 kW	8,8-26,4 kW
thermal power of water cycle	8 kW	9 kW	12 kW
energy efficiency class	A+	A+	A
flue size	200 mm	200 mm	200 mm
efficiency	88 %	81,1 %	80,1 %
flue gas temperature	192°C	274°C	289°C
maximum log length	500 mm	700 mm	850 mm
weight	~347 kg	~387 kg	~459 kg

Additional equipment

- black ceramiton
- removable handle for quillotines
- black handle
- double glass

Dimensions

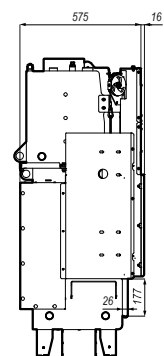
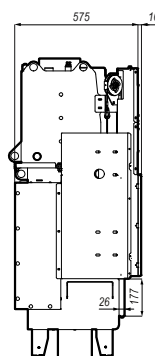
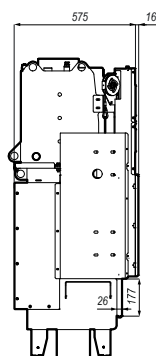
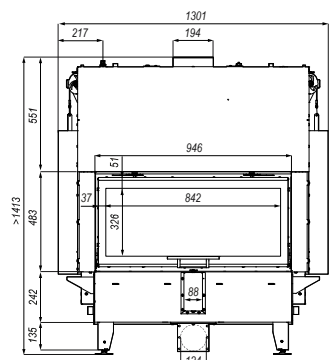
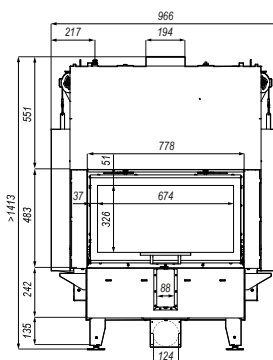
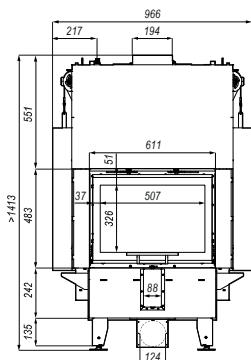

Inserts with a water cartridge with the side window opening upwards

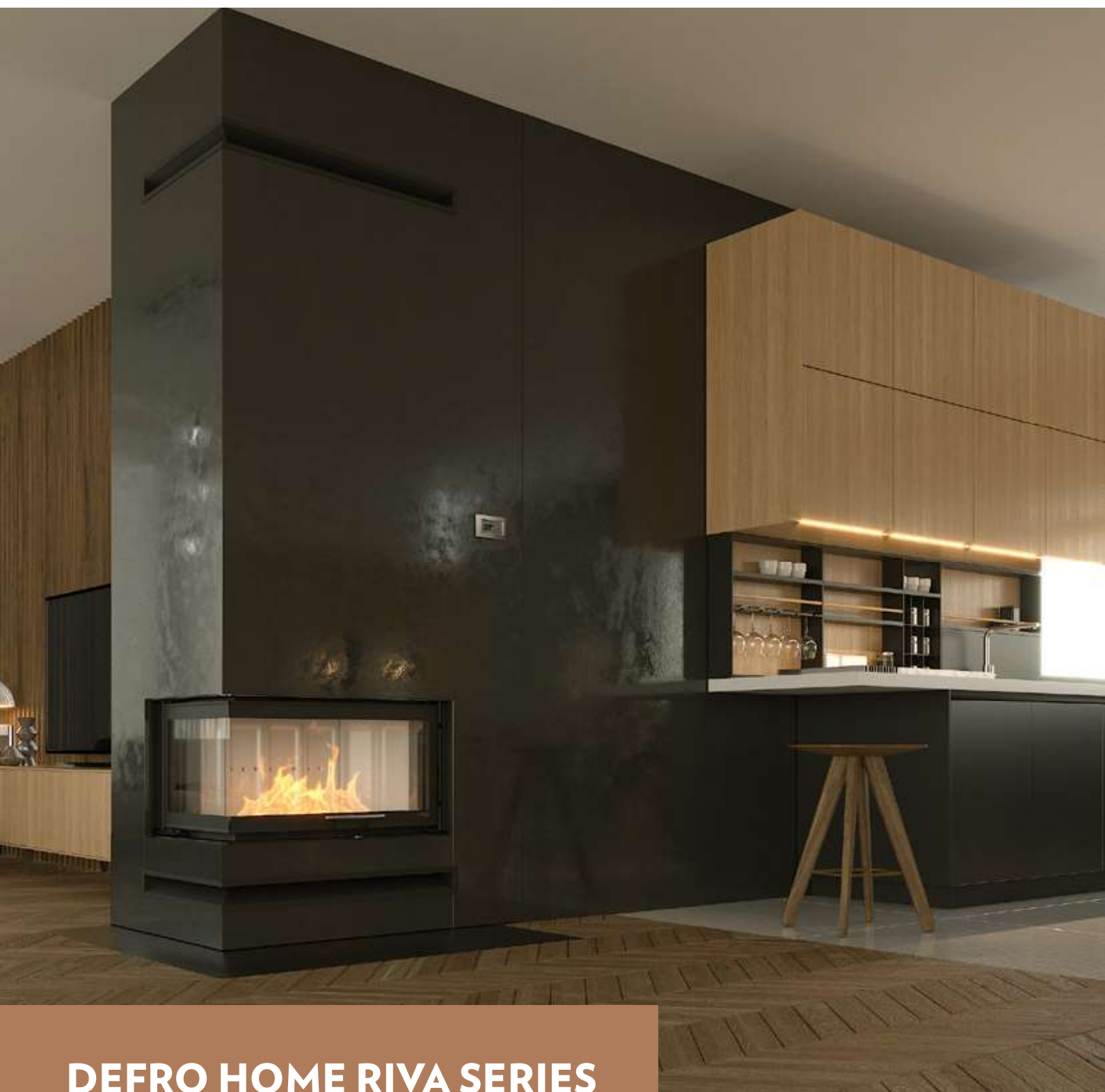

DEFRO HOME RIVA SERIES

The product visualization shows a fireplace insert with a water cartridge DEFRO HOME RIVA ME BL G SHORT.



Defro Home Riva
SM BP / BL G SHORT



Defro Home Riva
ME BP / BL G SHORT

Technical data

model / variant	SM	ME
nominal power	16 kW	19 kW
power range	6,4-19,2 kW	7,6-22,8 kW
thermal power of water cycle	8 kW	9 kW
energy efficiency class	A+	A+
flue size	200 mm	200 mm
efficiency	88 %	81,1 %
flue gas temperature	192 °C	274 °C
maximum log length	500 mm	700 mm
weight	~385 kg	~432 kg

Additional equipment

- black ceramiton
- black handle
- removable handle for quillotines

Dimensions

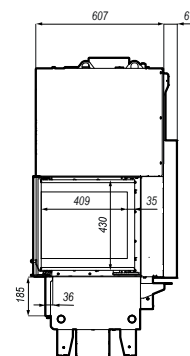
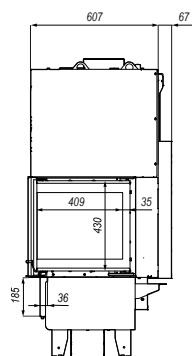
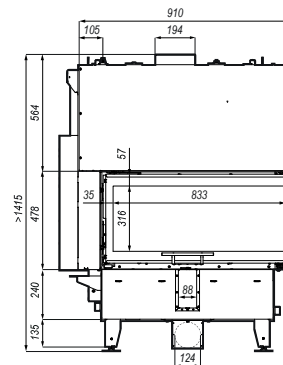
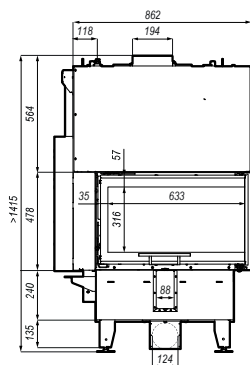

Inserts with a water cartridge with a straight glass opened to the side



DEFRO HOME NAVI SERIES

The product visualization shows a fireplace insert with a water cartridge DEFRO HOME NAVI SM.



Defro Home Navi
SM



Defro Home Navi
ME

Technical data

model / variant	SM	ME
nominal power	14 kW	17 kW
power range	5,6-16,8 kW	6,8-20,4 kW
thermal power of water cycle	10 kW	10 kW
energy efficiency class	A+	A+
flue size	200 mm	200 mm
efficiency	83,4 %	83,9 %
flue gas temperature	197°C	186°C
maximum log length	500 mm	700 mm
weight	-287 kg	-336 kg

Additional equipment

- black ceramiton
- black handle
- handle on the other side
- double glass

Dimensions

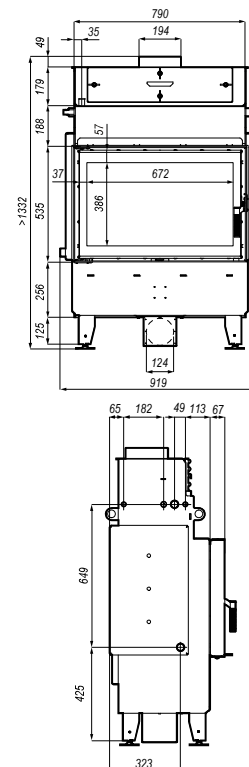
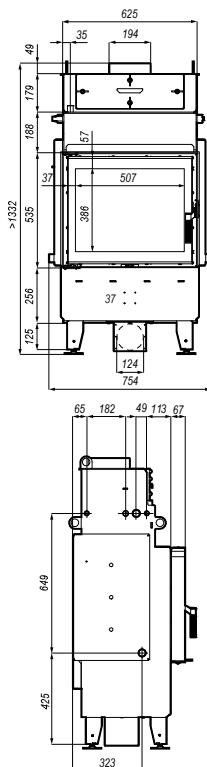

Inserts with a water cartridge with a straight glass opening upwards



DEFRO HOME NAVI SERIES

The product visualization shows a fireplace insert with a water cartridge DEFRO HOME NAVI SM G.



Defro Home Navi
SM G



Defro Home Navi
ME G

Technical data

model / variant	SM	ME
nominal power	14 kW	17 kW
power range	5,6-16,8 kW	6,8-20,4 kW
thermal power of water cycle	10 kW	10 kW
energy efficiency class	A+	A+
flue size	200 mm	200 mm
efficiency	83,4 %	83,9 %
flue gas temperature	197 °C	186 °C
maximum log length	500 mm	700 mm
weight	~338 kg	~387 kg

Additional equipment

- black ceramiton
- black handle
- removable handle for quillotines
- double glass

Dimensions

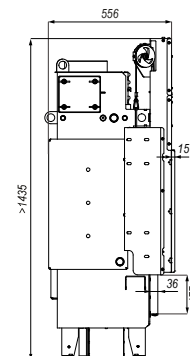
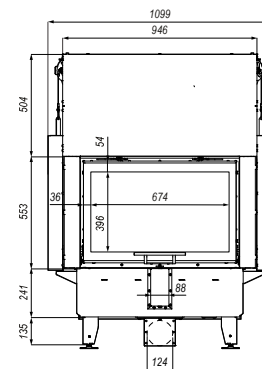
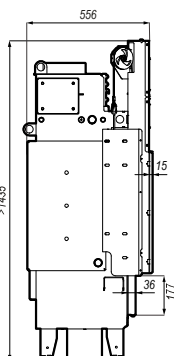
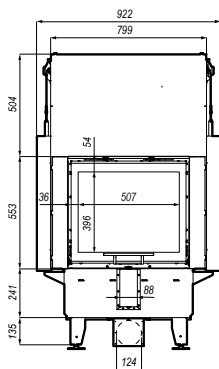

Straight frames

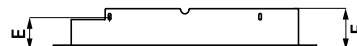
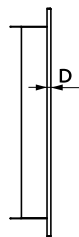
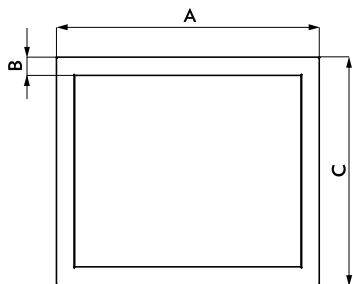
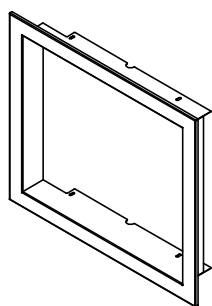

Straight frame
(M30 profile)

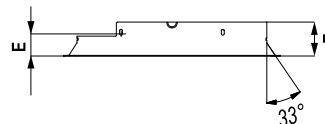
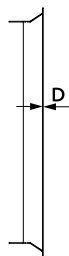
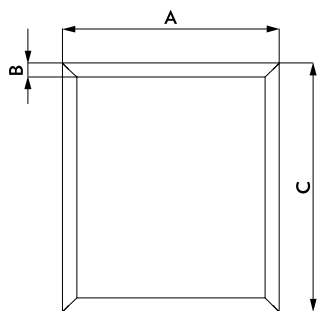
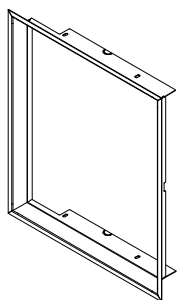

Straight frame
(Angular profile)

Fireplace specification				Dimensions in mm					
Fireplace name	Flange	Depth	Name	A	B	C	D	E	F
Defro Home Riva SM SHORT	M30	deep	RL_SM.SH.MASKOWN.30.GL	676	30	511	10	86	111
	M30	shallow	RL_SM.SH.MASKOWN.30.PL	676	30	511	10	24	51
Defro Home Riva ME SHORT	M30	deep	RL_ME.SH.MASKOWN.30.GL	841	30	511	10	86	111
	M30	shallow	RL_ME.SH.MASKOWN.30.PL	841	30	511	10	26	51
Defro Home Riva LA SHORT	M30	deep	RL_LA.SH.MASKOWN.30.GL	1011	30	511	11	86	111
	M30	shallow	RL_LA.SH.MASKOWN.30.PL	1011	30	511	10	24	51
Defro Home Riva SM G SHORT	M30	-	RL_SM.G.SH.MASKOWN.30	660,5	30	535	11	54,5	142,5
Defro Home Riva ME G SHORT	M30	-	RL_ME.G.SH.MASKOWN.30	827,5	30	535	11	54,5	142,5
Defro Home Riva LA G SHORT	M30	-	RL_LA.G.SH.MASKOWN.30	995,5	30	535	11	54,5	142,5
Defro Home Navi SM	M30	deep	PR_SM.MASKOWN.30.GL	676	30	581	11	86	111
	M30	shallow	PR_SM.MASKOWN.30.PL	676	30	581	10	25	51
Defro Home Navi ME	M30	deep	PR_ME.MASKOWN.30.GL	841	30	581	10	86	111
	M30	shallow	PR_ME.MASKOWN.30.PL	841	30	581	10	26	51
Defro Home Navi SM G	M30	deep	PR_SM.G.MASKOWN.30.GL	661	30	604	10	151	125
Defro Home Navi ME G	M30	deep	PR_ME.G.MASKOWN.30.GL	828	30	604	10	151	124

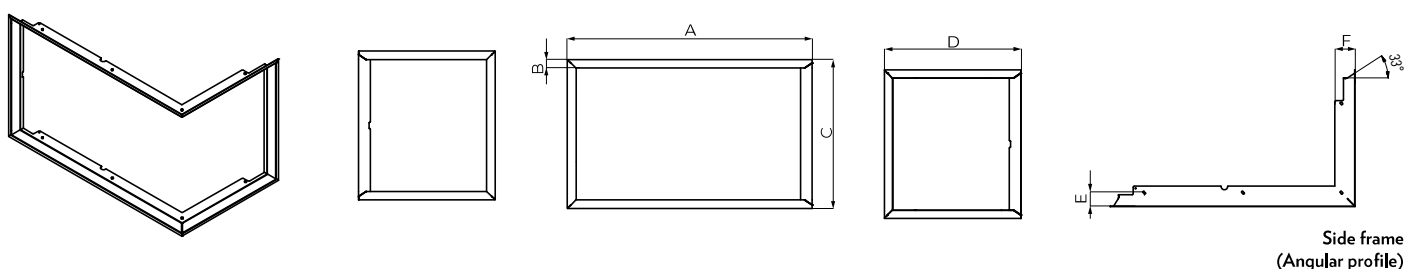
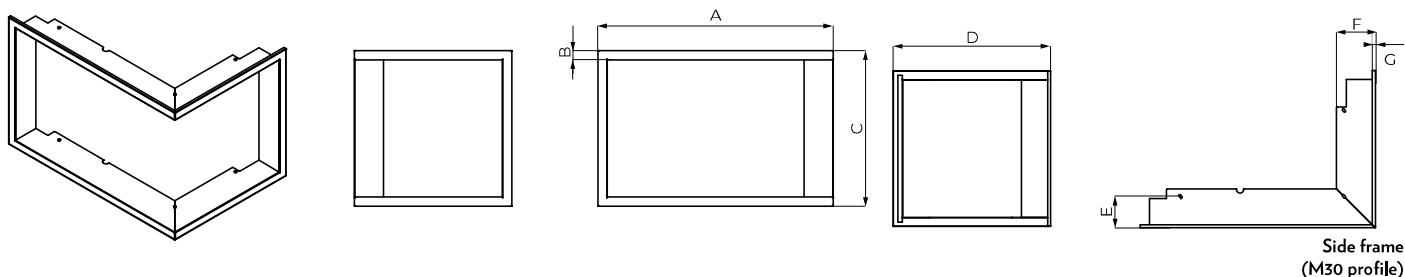

Fireplace specification				Dimensions in mm						
Fireplace name	Flange	Depth	Name	A	B	C	D	E	F	G
Defro Home Riva SM BL / BP SHORT	M30	deep	RI_SM.B.SH.MASKOWN.30.GL	842	30	511	587	100	128	10
	M30	shallow	RI_SM.B.SH.MASKOWN.30.PL	765	30	511	510	24	51	10
Defro Home Riva ME BL / BP SHORT	M30	deep	RI_ME.B.SH.MASKOWN.30.GL	1012	30	511	587	100	128	10
	M30	shallow	RI_SM.B.SH.MASKOWN.30.PL	935	30	511	510	24	51	10
Defro Home Riva SM BL / BP G SHORT	M30	deep	RI_SM.B.G.SH.MASKOWN.30.GL	849	30	529	593	71,5	142,5	10
	M30	shallow	RI_SM.B.G.SH.MASKOWN.30.PL	840	30	529	582	63	134	10
Defro Home Riva ME BL / BP G SHORT	M30	deep	RI_ME.B.G.SH.MASKOWN.30.GL	1016	30	530	593	71,5	142,5	10
	M30	shallow	RI_SM.B.G.SH.MASKOWN.30.PL	1007	30	530	585	63	134	10

Additional equipment

Model / Equipment availability	1. Black line overprint	2. Black handle	3. Black ceramiton	4. Double glass	5. Handle on the other side	6. Removable handle for guillotines	7. Removable handle for guillotines - separate purchase
Defro Home Navi SM	standard	✓	✓	✓	✓	-	-
Defro Home Navi SM G	standard	✓	✓	✓	✓	✓	✓
Defro Home Navi ME	standard	✓	✓	✓	✓	✓	✓
Defro Home Navi ME	standard	✓	✓	✓	✓	-	-
Defro Home Riva SM	standard	✓	✓	-	-	✓	✓
Defro Home Riva SM G	standard	✓	✓	-	✓	-	-
Defro Home Riva ME	standard	✓	✓	-	✓	-	-
Defro Home Riva ME G	standard	✓	✓	-	✓	-	-
Defro Home Riva LA	standard	✓	✓	-	✓	✓	✓
Defro Home Riva LA G	standard	✓	✓	-	✓	✓	✓
Defro Home Riva SM BL / BP	standard	✓	✓	-	-	-	-
Defro Home Riva SM BL / BP G	standard	✓	✓	-	✓	-	-
Defro Home Riva ME BL / BP	standard	✓	✓	-	-	✓	✓
Defro Home Riva ME BL / BP G	standard	✓	✓	-	-	✓	✓



DEFRO HOME ORBIS SERIES

The product visualization shows the DEFRO HOME ORBIS TOP freestanding wood stove.



Defro Home
Orbis



Defro Home
Orbis Top



Defro Home
Orbis Log

Technical data

model / variant	ORBIS	ORBIS TOP	ORBIS LOG
nominal power	9 kW	9 kW	9 kW
power range	3,6-10,8 kW	3,6-10,8 kW	3,6-10,8 kW
energy efficiency class	A	A	A
flue size	150 mm	150 mm	150 mm
efficiency	75,5 %	75,5 %	75,5 %
flue gas temperature	310,6° C	310,6° C	310,6° C
maximum log length	400 mm	400 mm	400 mm
weight	176 kg	174 kg	172 kg

Additional equipment

- black ceramiton
- color (red, white, gold, brown, gray)
- silver handle

Dimensions

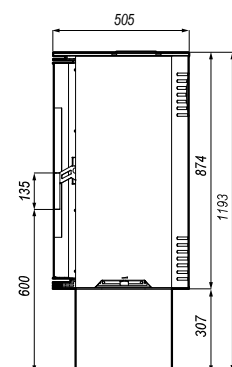
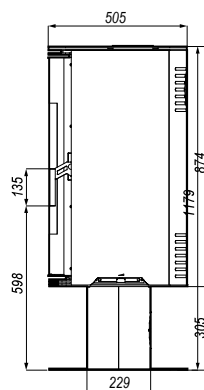
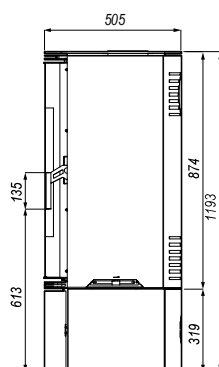
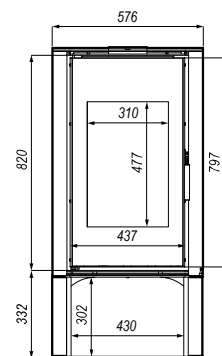
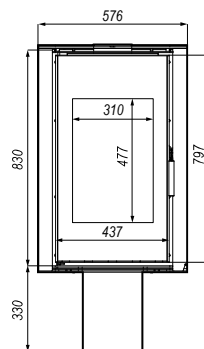
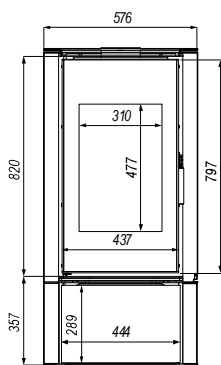

Freestanding wood stoves



DEFRO HOME SOLUM SERIES

The product visualization shows the DEFRO HOME SOLUM LOG freestanding wood stove.



Defro Home
Solum



Defro Home
Solum Top



Defro Home
Solum Log



Technical data

model / variant	SOLUM	SOLUM TOP	SOLUM LOG
nominal power	9 kW	9 kW	9 kW
power range	3,6-10,8 kW	3,6-10,8 kW	3,6-10,8 kW
energy efficiency class	A	A	A
flue size	150 mm	150 mm	150 mm
efficiency	75,5 %	75,5 %	75,5 %
flue gas temperature	310,6° C	310,6° C	310,6° C
maximum log length	400 mm	400 mm	400 mm
weight	157 kg	161 kg	165 kg

Additional equipment

- black ceramiton
- color (red, white, gold, brown, gray)
- silver handle

Dimensions

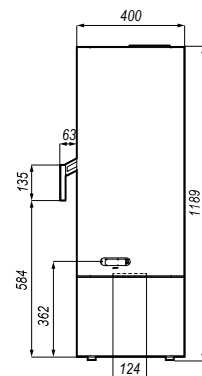
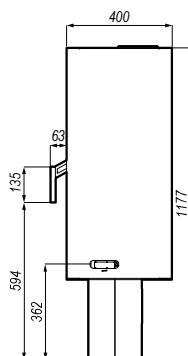
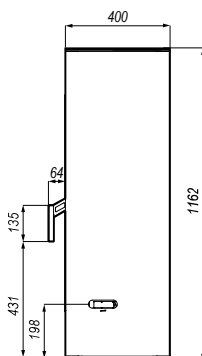
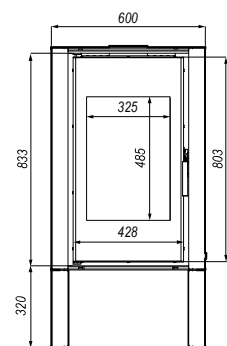
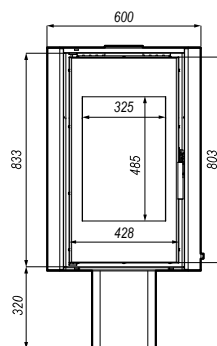
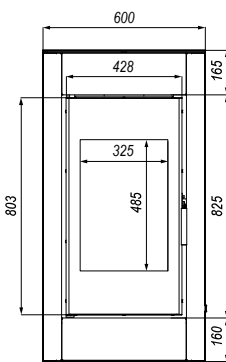

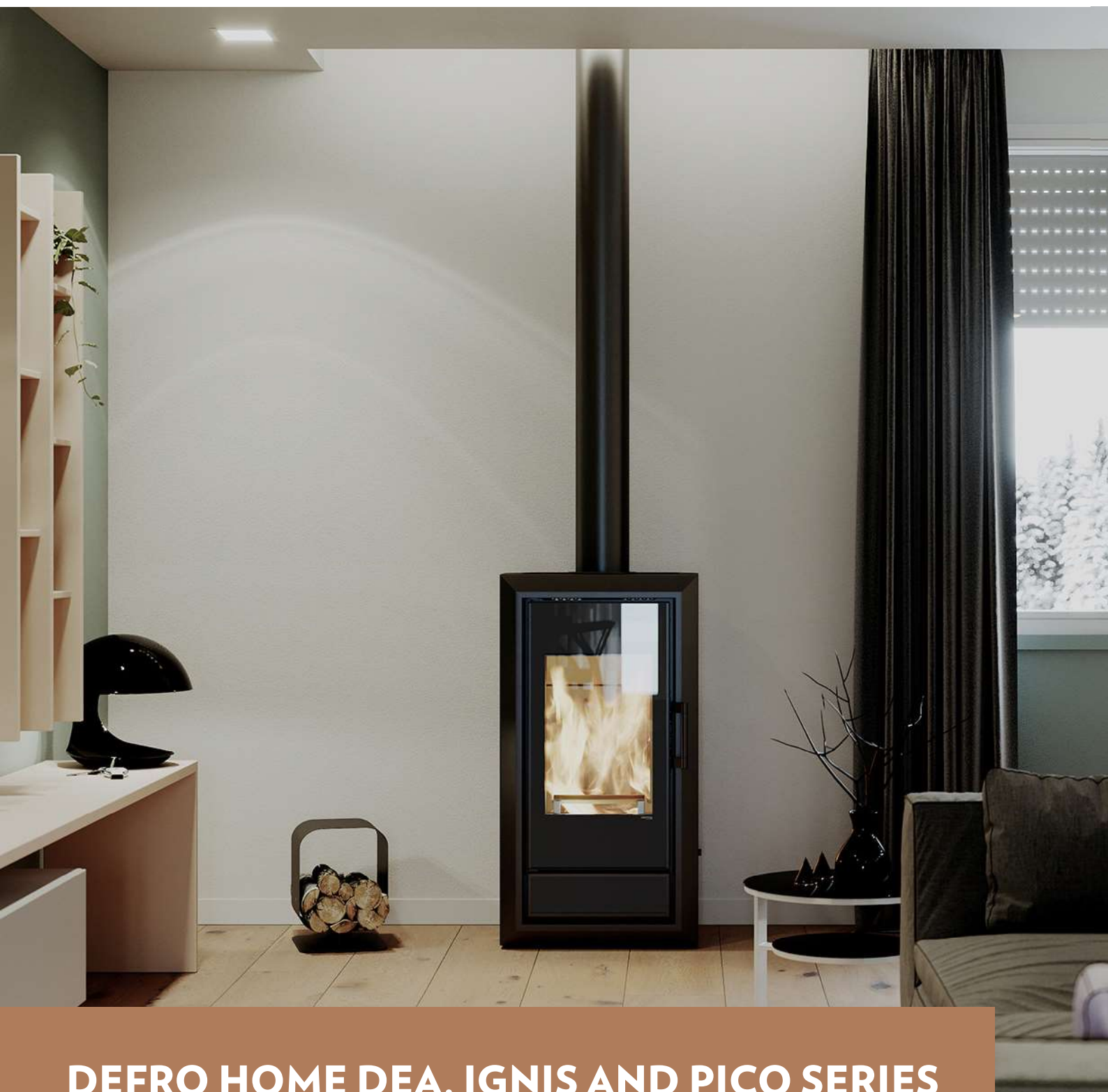

DEFRO HOME DEA, IGNIS AND PICO SERIES

The product visualization shows the DEFRO HOME IGNIS freestanding wood stove.



Technical data

model / variant	DEA	DEA TOP	DEA LOG	IGNIS
nominal power	9 kW	9 kW	9 kW	9 kW
power range	3,6-10,8 kW	3,6-10,8 kW	3,6-10,8 kW	3,6-10,8 kW
energy efficiency class	A	A	A	A
flue size	150 mm	150 mm	150 mm	150 mm
efficiency	75,5 %	75,5 %	75,5 %	75,5 %
flue gas temperature	310,6°C	310,6°C	310,6°C	310,6°C
maximum log length	400 mm	400 mm	400 mm	400 mm
weight	162 kg	146 kg	158 kg	~152 kg

Additional equipment

- black ceramiton - Ignis
- color (red, white, gold, brown, gray)
- silver handle

Dimensions

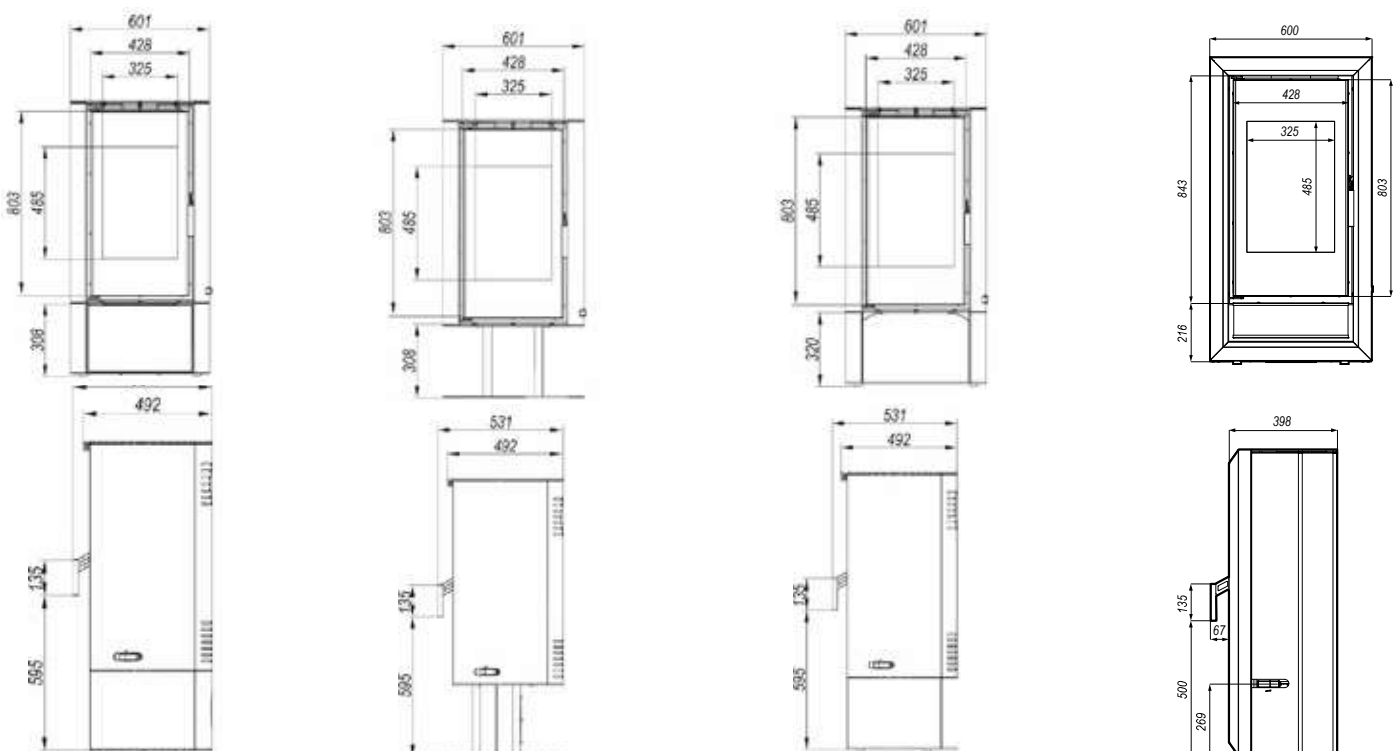

Freestanding wood stoves



DEFRO HOME OVAL, ORTI, ORBIS EXTENTO SERIES

The product visualization shows the DEFRO HOME OVAL freestanding wood stove.



Technical data

model / variant	OVAL	ORTI	EXTENTO H	EXTENTO F
nominal power	9 kW	9 kW	9 kW	9 kW
power range	3,6-10,8 kW	3,6-10,8 kW	3,6-10,8 kW	3,6-10,8 kW
energy efficiency class	A	A	A	A
flue size	150 mm	150 mm	150 mm	150 mm
efficiency	75,5 %	75,5 %	75,5 %	75,5 %
flue gas temperature	310,6 °C	310,6 °C	310,6 °C	310,6 °C
maximum log length	400 mm	400 mm	400 mm	400 mm
weight	~175 kg	~170 kg	200 kg	191 kg

Additional equipment

- black ceramiton
- color (red, white, gold, brown, gray)
- silver handle

Dimensions

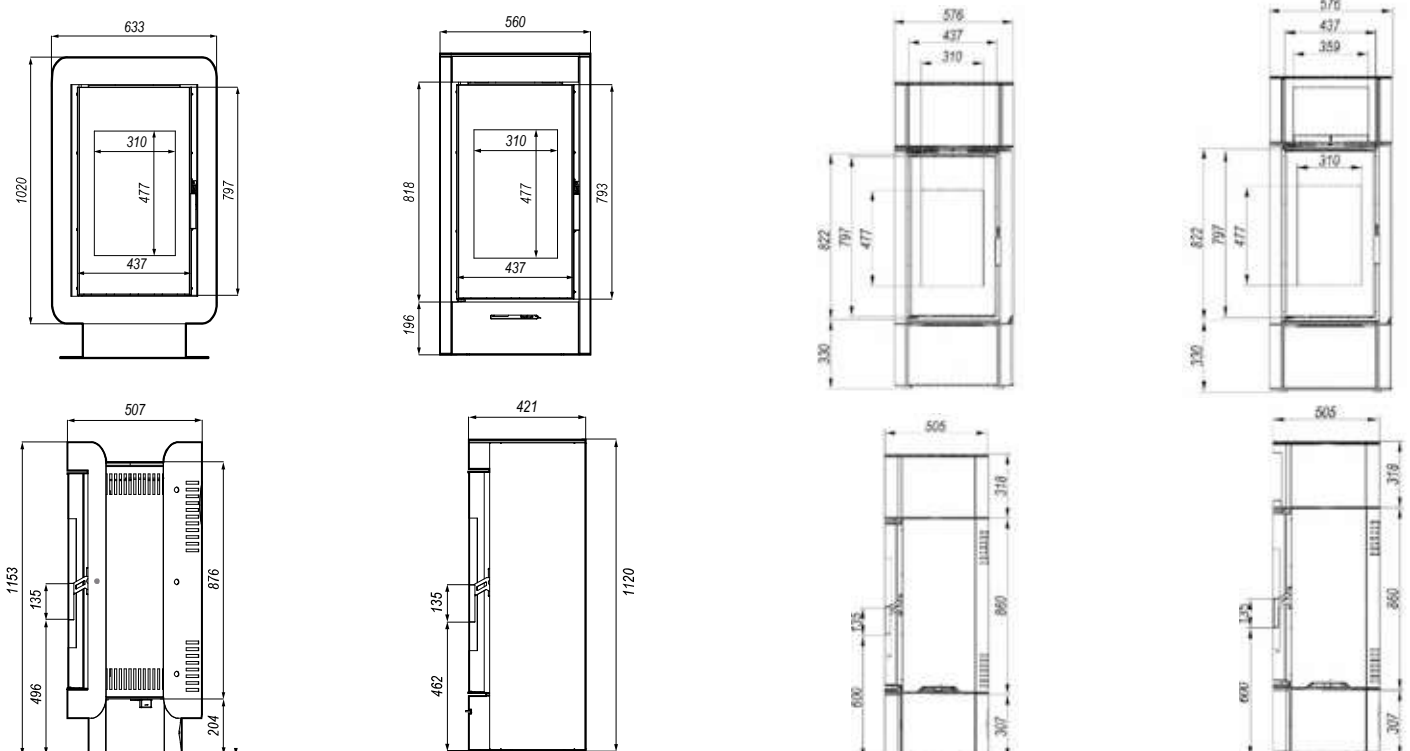

Freestanding wood stoves



DEFRO HOME QUADROOM SERIES

The product visualization shows the DEFRO HOME QUADROOM freestanding wood stove.



Defro Home
Quadroom



Defro Home
Quadroom Long

Technical data

model / variant	QUADROOM	QUADROOM LONG
nominal power	9,6 kW	9,6 kW
energy efficiency class	A	A+
flue size	146 mm	146 mm
efficiency	80,2 %	80,4 %
flue gas temperature	252 °C	266 °C
maximum log length	300-350 mm	200 mm
weight	154 kg	165 kg

Additional equipment

- black ceramiton
- color (red, white, gold, brown, gray)
- silver handle

Dimensions

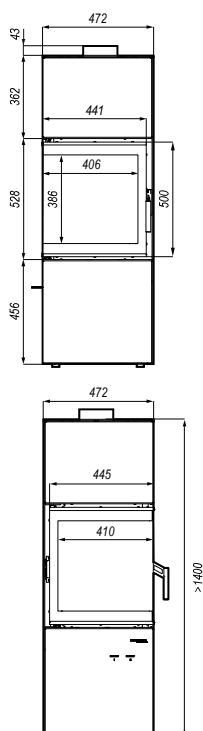



DEFRO HOME VIVA AND CUBE MINI SERIES

The product visualization shows the DEFRO HOME VIVA freestanding wood stove.



Defro Home
Viva



available soon

Defro Home
Cube Mini



Defro Home
Pico



Tabela techniczna

model / variant	VIVA	CUBE MINI	PICO
nominal power	6,6 kW	6,6 kW	6,6 kW
power range	2,6-7,9 kW	2,6-7,9 kW	2,6-7,9 kW
energy efficiency class	A+	A+	A+
flue size	146 mm	146 mm	146 mm
efficiency	82,5 %	82,5 %	82,5 %
flue gas temperature	250°C	250°C	250°C
maximum log length	400 mm	400 mm	400 mm
weight	-133 kg	-134 kg	-130 kg

Additional equipment

- color (red, white, gold, brown, gray)
- silver handle

Dimensions

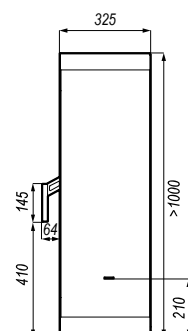
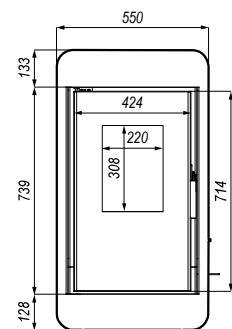
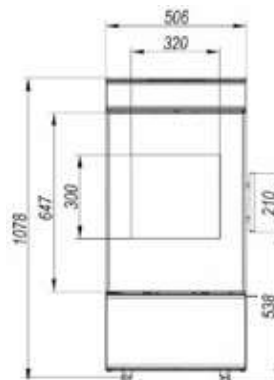
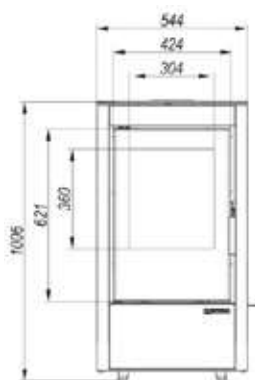

Freestanding wood stoves



DEFRO HOME CERES SERIES

The product visualization shows the DEFRO HOME CERES freestanding wood stove.



Defro Home
Ceres



Defro Home
Ceres Top



Defro Home
Ceres Eli

Technical data

model / variant	CERES	CERES TOP	CERES ELI
nominal power	6,6 kW	6,6 kW	6,6 kW
power range	2,6-7,9 kW	2,6-7,9 kW	2,6-7,9 kW
energy efficiency class	A+	A+	A+
flue size	146 mm	146 mm	146 mm
efficiency	82,5 %	82,5 %	82,5 %
flue gas temperature	250°C	250°C	250°C
maximum log length	400 mm	400 mm	400 mm
weight	147 kg	160 kg	145 kg

Additional equipment

- color (red, white, gold, brown, gray)
- silver handle

Dimensions

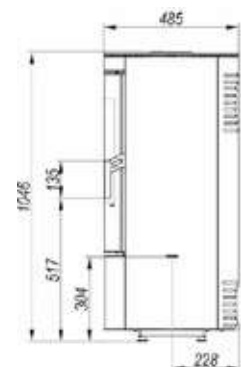
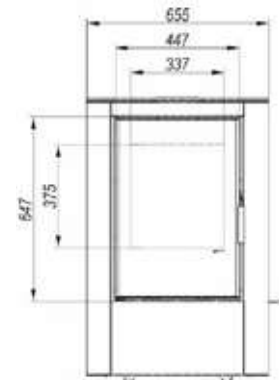
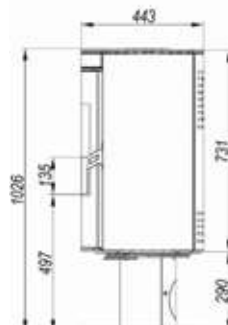
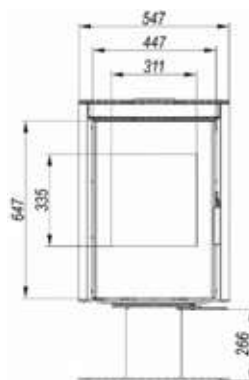
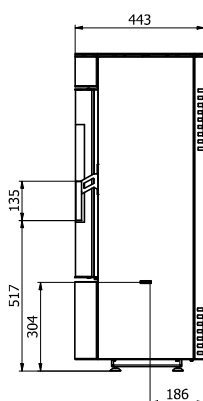
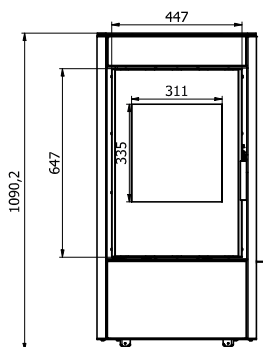

Freestanding pellet stoves



DEFRO HOME MYPELL SERIES

The product visualization shows a free-standing DEFRO HOME MYPELL pellet stove.



Defro Home
Mypell DGP

Technical data

model / variant	MYPELL DGP
nominal power	9 kW
power range	3,6-10,8 kW
energy efficiency class	A+
flue size	80 mm
efficiency	90,9 %
flue gas temperature	138 °C
weight	~152 kg

Additional equipment

- silver handle
- color (red, white, gold, brown, gray)

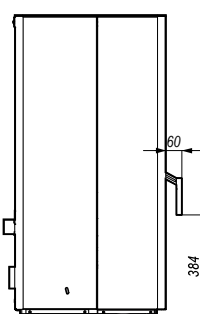
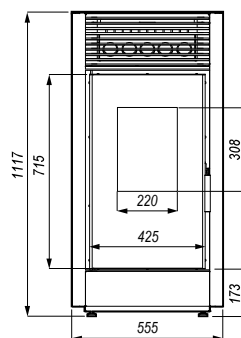

Freestanding pellet stoves



DEFRO HOME SLIMPELL AND AIRPELL SERIES

The product visualization shows a free-standing DEFRO HOME AIRPELL pellet stove.



Defro Home
Slimpell



Defro Home
Airpell

Technical data

model / variant	SLIMPELL	AIRPELL
nominal power	9 kW	8 kW
power range	3,6-10,8 kW	3,2-9,6 kW
energy efficiency class	A+	A++
flue size	80 mm	80 mm
efficiency	90,9 %	93,3 %
flue gas temperature	138 °C	82,1 °C
weight	~165 kg	~146 kg

Additional equipment

- color (red, white, gold, brown, gray)
- silver handle - Slimpell
- wooden finish - Airpell

Dimensions

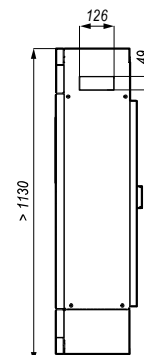
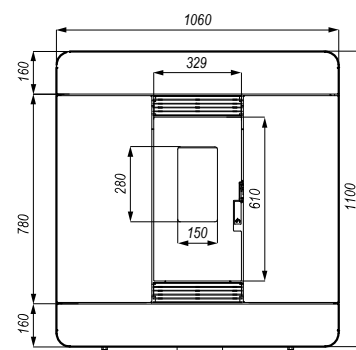
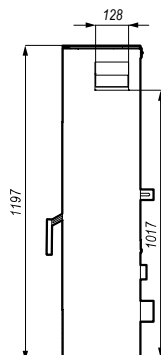
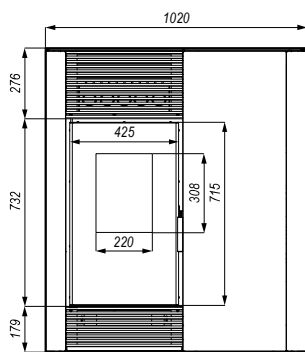



DEFRO HOME OMNIPPELL AND MINIPELL SERIES

The product visualization shows a free-standing DEFRO HOME MINIPELL pellet stove.



Defro Home
Omnipell



Defro Home
Aquapell

Technical data

model / variant	OMNIPPELL	AQUAPELL
nominal power	8 kW	13,1 kW
power range	3,2-9,6 kW	5,2-15,7 kW
energy efficiency class	A+	10,2 kW
flue size	80 mm	80 mm
efficiency	88,7 %	95,1 %
flue gas temperature	195°C	84,2°C
weight	~150 kg	~165 kg

Additional equipment

- color (red, white, gold, brown, gray)

Dimensions

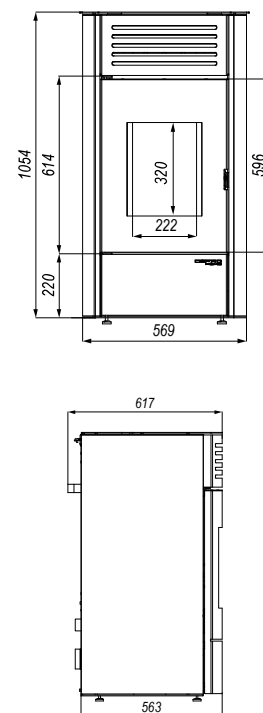
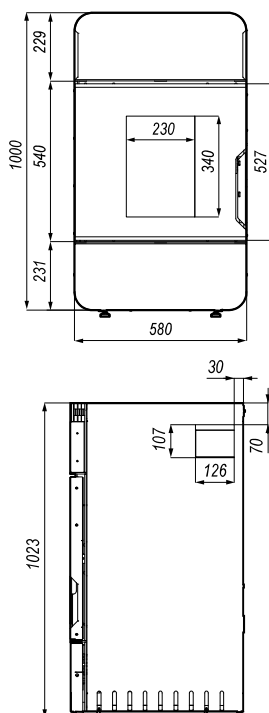

Additional equipment



Model / equipment availability	1. Black ceramiton	2. Silver handle
Defro Home Orbis / Orbis Top / Orbis Log	✓	✓
Defro Home Solum / Solum Top / Solum Log	✓	✓
Defro Home Dea	✓	✓
Defro Home Ceres / Ceres Top	✓	✓
Defro Home Quadroom / Quadroom Long	✓	✓
Defro Home Ignis	✓	✓
Defro Home Orti	✓	✓
Defro Home Oval	✓	✓
Defro Home Pico	✓	✓
Defro Home Viva	✓	✓
Defro Home Extento H	✓	✓
Defro Home Extento F	✓	✓



Model / availability of colors	Black	Brown	Gray	Gold	White	Red
Defro Home Orbis / Orbis Top / Orbis Log	standard	✓	✓	✓	✓	✓
Defro Home Solum / Solum Top / Solum Log	standard	✓	✓	✓	✓	✓
Defro Home Dea	standard	✓	✓	✓	✓	✓
Defro Home Ceres / Ceres Top	standard	✓	✓	✓	✓	✓
Defro Home Quadroom / Quadroom Long	standard	✓	✓	✓	✓	✓
Defro Home Ignis	standard	✓	✓	✓	✓	✓
Defro Home Orti	standard	✓	✓	✓	✓	✓
Defro Home Oval	standard	-	-	-	-	-
Defro Home Pico	standard	✓	✓	✓	✓	✓
Defro Home Viva	standard	✓	✓	✓	✓	✓
Defro Home Extento H	standard	✓	✓	✓	✓	✓
Defro Home Extento F	standard	✓	✓	✓	✓	✓

Additional equipment

Model / Equipment availability	1. Silver handle
Defro Home Mypell	✓
Defro Home Slimpell	✓
Defro Home Omnipell	✓
Defro Home Minipell	✓
Defro Home Aquapell	✓
Defro Home Airpell	✓
Defro Home Mypell DGP	✓



Wood finish



Model / Equipment availability	Wood finish
Defro Home Airpell	✓



Model / availability of colors	Black	Brown	Gray	Gold	White	Red
Defro Home Mypell	standard	✓	✓	✓	✓	✓
Defro Home Slimpell	standard	✓	✓	✓	✓	✓
Defro Home Omnipell	standard	✓	✓	✓	✓	✓
Defro Home Minipell	standard	-	-	-	-	-
Defro Home Aquapell	standard	✓	✓	✓	✓	✓
Defro Home Airpell	standard	✓	✓	✓	✓	✓
Defro Home Mypell DGP	standard	✓	✓	✓	✓	✓

Minimum values of the active field (inlet and outlet)



Suggested values for active field at inlet and outlet			
Name	Power in kW	Minimum air inlet area in cm ²	Minimum air discharge area in cm ²
Defro Home Intra XSM	8	400	560
Defro Home Intra SM / SM G / SM T / SM T G	10	500	700
Defro Home Intra ME / ME G / ME T / ME T G	13	650	910
Defro Home Intra LA / LA G / LA T / LA T G	16	800	1120
Defro Home Intra XSM BL / BP MINI	8	400	560
Defro Home Intra SM BL / BP MINI	10	500	700
Defro Home Intra SM BL / BP	10	500	700
Defro Home Intra ME BL / BP	13	650	910
Defro Home Intra XSM BL / BP MINI G	8	400	560
Defro Home Intra SM BL / BP MINI G	10	500	700
Defro Home Intra SM BL / BP G	10	500	700
Defro Home Intra ME BL / BP G	13	650	910
Defro Home Intra SM C	10	500	700
Defro Home Intra XSM C G	8	400	560
Defro Home Intra SM C G	10	500	700
Defro Home Intra ME C G	13	650	910
Defro Home Intra SM SLIM / SM SLIM G	6	300	420
Defro Home Intra ME SLIM / ME SLIM G	8	400	560
Defro Home Intra SM BL SLIM / BP SLIM	6	300	420
Defro Home Intra ME BL SLIM / BP SLIM	8	400	560
Defro Home Intra SM BL G SLIM / BP G SLIM	6	300	420
Defro Home Intra ME BL G SLIM / BP G SLIM	8	400	560
Defro Home Impuls SM	8	400	560
Defro Home Impuls ME	10	500	700
Defro Home Impuls SM BL / BP	8	400	560
Defro Home Impuls ME BL / BP	10	500	700
Defro Home Portal ME / ME G	12	600	840

Lufts - 80 size			
Name	Size	Index	Active field (cm ²)
DH Luft 200x90 (80)	200x90 (80)	DH/L/200x90(80)	84
DH Luft 480x90 (80)	480x90 (80)	DH/L/480x90(80)	210
DH Luft 650x90 (80)	650x90 (80)	DH/L/650x90(80)	292
DH Luft 810x90 (80)	810x90 (80)	DH/L/810x90(80)	370
DH Luft 980x90 (80)	980x90 (80)	DH/L/980x90(80)	442

Lufts - 120 size			
Name	Size	Index	Active field (cm ²)
DH Luft 200x90 (120)	200x90 (120)	DH/L/200x90(120)	92
DH Luft 480x90 (120)	480x90 (120)	DH/L/480x90(120)	321
DH Luft 650x90 (120)	650x90 (120)	DH/L/650x90(120)	322
DH Luft 810x90 (120)	810x90 (120)	DH/L/810x90(120)	408
DH Luft 980x90 (120)	980x90 (120)	DH/L/980x90(120)	499

Corner lufts - 80 size			
Name	Size	Index	Active field (cm ²)
DH Luft corner right 400x740x90 (80)	400x740x90 (80)	DH/L/NP/400x740x90(80)	462
DH Luft corner left 740x400x90 (80)	740x400x90 (80)	DH/L/NL/740x400x90(80)	462
DH Luft corner right 400x910x90 (80)	400x910x90 (80)	DH/L/NP/400x910x90(80)	544
DH Luft corner left 910x400x90 (80)	910x400x90 (80)	DH/L/NL/910x400x90(80)	544
DH Luft corner right 470x740x90 (80)	470x740x90 (80)	DH/L/NP/470x740x90(80)	496
DH Luft corner left 740x470x90 (80)	740x470x90 (80)	DH/L/NL/740x470x90(80)	496
DH Luft corner right 540x810x90 (80)	540x810x90 (80)	DH/L/NP/540x810x90(80)	564
DH Luft corner left 810x540x90 (80)	810x540x90 (80)	DH/L/NL/810x540x90(80)	564
DH Luft corner right 540x980x90 (80)	540x980x90 (80)	DH/L/NP/540x980x90(80)	646
DH Luft corner left 980x540x90 (80)	980x540x90 (80)	DH/L/NL/980x540x90(80)	646

Corner lufts - 120 size			
Name	Size	Index	Active field (cm ²)
DH Luft corner right 400x740x90 (120)	400x740x90 (120)	DH/L/NP/400x740x90(120)	515
DH Luft corner left 740x400x90 (120)	740x400x90 (120)	DH/L/NL/740x400x90(120)	515
DH Luft corner right 400x910x90 (120)	400x910x90 (120)	DH/L/NP/400x910x90(120)	615
DH Luft corner left 910x400x90 (120)	910x400x90 (120)	DH/L/NL/910x400x90(120)	615
DH Luft corner right 470x740x90 (120)	470x740x90 (120)	DH/L/NP/470x740x90(120)	556
DH Luft corner left 740x470x90 (120)	740x470x90 (120)	DH/L/NL/740x470x90(120)	556
DH Luft corner right 540x810x90 (120)	540x810x90 (120)	DH/L/NP/540x810x90(120)	638
DH Luft corner left 810x540x90 (120)	810x540x90 (120)	DH/L/NL/810x540x90(120)	638
DH Luft corner right 540x980x90 (120)	540x980x90 (120)	DH/L/NP/540x980x90(120)	737
DH Luft corner left 980x540x90 (120)	980x540x90 (120)	DH/L/NL/980x540x90(120)	737

Suggested values for active field at inlet and outlet			
Name	Power in kW	Minimum air inlet area in cm ²	Minimum air discharge area in cm ²
Defro Home Intra XSM	8	400	560
Defro Home Intra SM / SM G / SM T / SM T G	10	500	700
Defro Home Intra ME / ME G / ME T / ME T G	13	650	910
Defro Home Intra LA / LA G / LA T / LA T G	16	800	1120
Defro Home Intra XSM BL / BP MINI	8	400	560
Defro Home Intra SM BL / BP MINI	10	500	700
Defro Home Intra SM BL / BP	10	500	700
Defro Home Intra ME BL / BP	13	650	910
Defro Home Intra XSM BL / BP MINI G	8	400	560
Defro Home Intra SM BL / BP MINI G	10	500	700
Defro Home Intra SM BL / BP G	10	500	700
Defro Home Intra ME BL / BP G	13	650	910
Defro Home Intra SM C	10	500	700
Defro Home Intra XSM C G	8	400	560
Defro Home Intra SM C G	10	500	700
Defro Home Intra ME C G	13	650	910
Defro Home Intra SM SLIM / SM SLIM G	6	300	420
Defro Home Intra ME SLIM / ME SLIM G	8	400	560
Defro Home Intra SM BL SLIM / BP SLIM	6	300	420
Defro Home Intra ME BL SLIM / BP SLIM	8	400	560
Defro Home Intra SM BL G SLIM / BP G SLIM	6	300	420
Defro Home Intra ME BL G SLIM / BP G SLIM	8	400	560
Defro Home Impuls SM / SM G	8	400	560
Defro Home Impuls ME / ME G	10	500	700
Defro Home Impuls SM BL / BP	8	400	560
Defro Home Impuls ME BL / BP	10	500	700
Defro Home Impuls SM BL / BP G	8	400	560
Defro Home Impuls ME BL / BP G	10	500	700
Defro Home Portal ME / ME G	12	600	840

DEFRO
home

Producent: DEFRO R. Dziubela spółka komandytowa,
26-067 Strawczyn, Ruda Strawczyńska 103A,
KRS: 0000620901, NIP: 9591968493, REGON: 363378898
tel.: 41 303 80 85, e-mail: biuro@defro.pl

Current product prices are available at authorized DEFRO distributors or at authorized points of sale.

The list of authorized points of sale is available at www.defrohome.com
Visualizations and dimensions of products in the catalog are illustrative.

ENG 02/2022