

FIREPLACE INSERTS 2023/24

„TIMES MAY  
CHANGE,  
BUT *my fire*  
STILL  
BURNS.“



AUSTROFLAMM

[www.austroflamm.com](http://www.austroflamm.com)



40  
YEARS

www.austroflamm.com

Always  
plunging into  
new worlds  
of fire!

index

C O N T E N T S

**04**  
Ahead of the Times

**06**  
New & Innovative

**10**  
Austroflamm Technology

**20**  
Fireplace Inserts / Impressions

**52**  
Technical Details





4



Teresa Huemer



Ferdinand Huemer



Sebastian Köck



Doris Pfeiffer

40 YEARS

www.austroflamm.com

# Fire is the source of all things.

FERDINAND HUEMER, A VERSATILE PIONEER



THE SUCCESS STORY BEGAN BACK IN 1983 when Ferdinand Huemer, the company founder, hit on the idea of combining efficient wood-burning stoves with innovative design. Then in 1995, the easy-to-use pellet stove was born. Fuelled by creativity, a zest for action, courage and determination, he transformed his company into a permanent fixture on the wood burner market in record time!

AUSTROFLAMM IS THE PIONEER in the use of ceramics, developing innovative storage materials such as HMS (Heat Memory System), XTRA storage heat and

Keramott, which was developed and produced in-house - and was therefore instrumental in significantly reducing the emission values for solid fuels. Austroflamm stove setting accessories in premium quality perfectly round off our product portfolio for stove construction!

ALWAYS ONE STEP AHEAD OF THE ZEITGEIST, we have developed a brand new baking compartment that can be incorporated into many fireplace inserts. Being independent and using the heat sustainably for cooking is nothing less than perfect!

*Thinking and acting sustainably, team spirit and a culture of partnership have been the hallmarks of our company for 40 years.*







# Baking compartment for fireplace inserts



## TASTEFUL FIREPLACE ENHANCEMENT!

For your newly found independence, we have developed a real treat for you at Austroflamm: a **FIREPLACE INSERT WITH BAKING COMPARTMENT!** A product perfect for stove construction - innovative and individually configurable! This new baking compartment for fireplace inserts in the familiar quality of this traditional Austrian company means you can now also utilise the energy from the fireplace insert for a fully-fledged baking compartment!

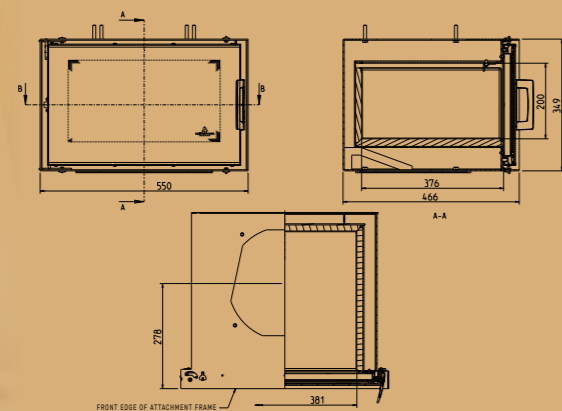

➔ BAKING COMPARTMENT

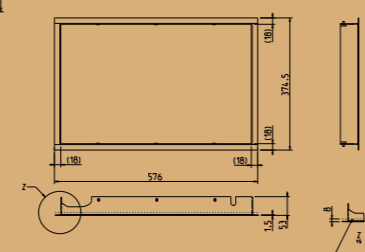

➔ DESIGNER FRAME



➔ BAKING COMPARTMENT / SECTIONAL VIEW

AUSTROFLAMM TECHNOLOGY

## NEW! FIREPLACE INSERT WITH BAKING COMPARTMENT

Available for the following fireplace insert models:  
45x51K, 45x57K, 45x68K, 55x45K, 55x51K,  
55x57K, 65x45K, 65x51K, 65x57K,  
75x39K, 75x57K

FIREPLACE INSERT 55X51K  
WITH BAKING COMPARTMENT

NEW





# WOOD BURNER COOK BOOK

NEW

BEING INDEPENDENT  
SIMPLY *tastes*  
SO MUCH BETTER

RECIPES FOR WOOD-BURNING STOVES

**AUSTROFLAMM**  
www.austroflamm.com

**Semolina dumpling SOUP**  
INGREDIENTS  
- 5 tbsp semolina  
- 1 pinch of salt  
- 1 egg  
- 1 good pinch of baking powder  
- approx. 1/2 litre of beef or vegetable stock  
- 2 carrots, optional

**Cream SOUP**  
INGREDIENTS  
- 1/4 l water  
- 4 tbsp sour cream  
- 1 tsp flour  
- salt  
- caraway seeds

**Noodle and vegetable SOUP**  
INGREDIENTS  
- soup noodles  
- 2-3 carrots, 1 leek, peas or mangrout  
- approx. 1/2 litres of beef or vegetable stock

**Grilled ROAST PORK**  
INGREDIENTS  
- approx. 1.5 kg loin of pork/neck of pork with bone and rind (cut into a rectangular pattern)  
- 2 onions, 3 carrots, 2 cloves of garlic  
- 2 tins, caraway seeds, salt, pepper, butter/margarine  
- 500 ml vegetable or meat stock  
(a person may also be substituted for beer)

**BEEF RAGOUT**  
INGREDIENTS  
- 1/2 kg beef goulash meat  
- 1 packet of goulash sauce mix  
- 1 l water

**BISCUITS**  
INGREDIENTS  
- 250 g rye flour  
- 50 g butter  
- 1 tbsp. Lebkuchen  
- Speyerbread spice  
- 1/2 tsp. bicarbonate of soda  
- 25 g butter  
- 120 g honey  
- 1 egg  
- 1 tbsp. water  
- egg for brushing (beaten)

**Honey LEBKUCHEN**  
INGREDIENTS  
- 250 g rye flour, sugar, baking soda, spices and butter.  
- 50 g butter  
- 1 tbsp. Lebkuchen  
- Speyerbread spice  
- 1/2 tsp. bicarbonate of soda  
- 25 g butter  
- 120 g honey  
- 1 egg  
- 1 tbsp. water  
- egg for brushing (beaten)

**Kaiser-SCHMARRN**  
INGREDIENTS  
- 4 eggs  
- 4 tbsp. flour (plain)  
- 1 tbsp. granulated sugar  
- 60 ml milk  
- vanilla sugar  
- saltless (optional)  
- butter (for baking)  
- granulated sugar, and flaked almonds if desired



TO CELEBRATE OUR 40TH ANNIVERSARY, WE HAVE FORKED UP A TASTY SURPRISE FOR YOU!  
Heating while cooking something delicious using the heat from the stove is not only sustainable, it's also economical!  
Tip: The new stove cookbook is also available for download on our homepage!





*Heating x 1 =  
double savings*

THE AQUAHEAT WOOD FIREPLACE INSERT is a real energy-saving champion with energy efficiency class A+. Hot water from the 49 l water tank is fed into the heating circuit. **This means that your central heating consumes less energy!** The AQUAHEAT unit is notable for its extremely simple operation.

**TIP:** When combined with solar energy, you can do without any external energy for many days. Use it to produce hot water for underfloor heating, for example, and hot water for baths and showers.

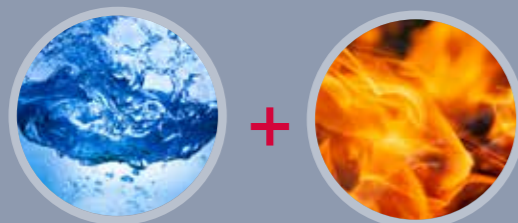

AUSTROFLAMM TECHNOLOGY  
**AQUAHEAT**  
WATER-BEARING  
FIREPLACE INSERT  
(WOOD)



65X51-K-AQUAHEAT  
FITTED WITH A 49 L WATER TANK  
FOR SUPPLEMENTING  
YOUR CENTRAL HEATING SYSTEM



**AQUAHEAT**  
WATER-BEARING  
FIREPLACE SYSTEM





We are committed to *sustainability!*

AUSTROFLAMM TECHNOLOGY  
FIREBOX LINING/  
KERAMOTT

KERAMOTT - PATENTED AUSTROFLAMM TECHNOLOGY

CUTTING-EDGE FIREPLACE SYSTEMS not only demand design ideas but also enormous development work in the field of combustion technology.

**A key example of this is the firebox lining:**

The firebox lining is one of the most important components of a fireplace insert, wood-burning or pellet stove. It is precisely with this in mind that we have developed Keramott.

**Low-emission combustion**

Keramott is characterised by a special balance between heat insulation and heat conduction, enabling high temperatures to be reached more quickly in the firebox. Only then is "clean", low-emission combustion possible.

**Superior castability.** This enables special shapes to be formed, thereby preventing the firebox lining from coming into contact with the fuel, and improving the air flow which in turn hinders the formation of so-called "cool spots".

**Lower cleaning effort**

At the same time, the material is highly heat-resistant up to approx. 1,200 °C. This also allows the firebox to "cleanburn"; the lining is less susceptible to soot and retains its light colour.

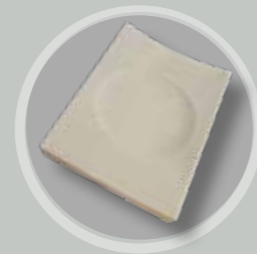

White KERAMOTT



Black KERAMOTT

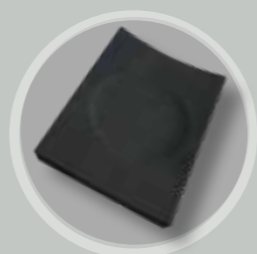

All Austroflamm stove units feature a firebox lined with KERAMOTT



6 4 X 3 3 X 5 1 S 3 WITH WHITE KERAMOTT



# HEAT MEMORY SYSTEM / HMS

## HEAT MEMORY SYSTEM

**PATENTED & OUTSTANDING:** Store heat easily and efficiently with the patented Heat Memory System from Austroflamm! The heavy hydraulically bonded storage mass (volume weight 2.7 kg/l) boasting a high heat retention capacity can absorb heat directly on the exterior of the firebox and then radiate it again for a prolonged period of time.

**IMPORTANT:** The storage mass must be placed as close as possible to the source of heat, i.e. the firebox of the stove.

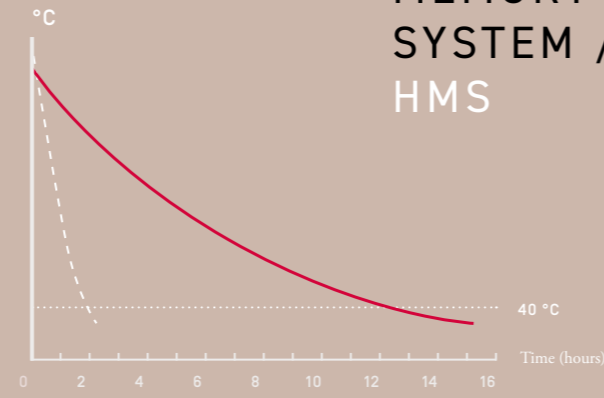

--- Fireplace insert without Heat Memory System  
 — Fireplace insert with Heat Memory System

This is why at Austroflamm we pack the storage mass directly into the stoves. Needless to say, the installation method is also patented.

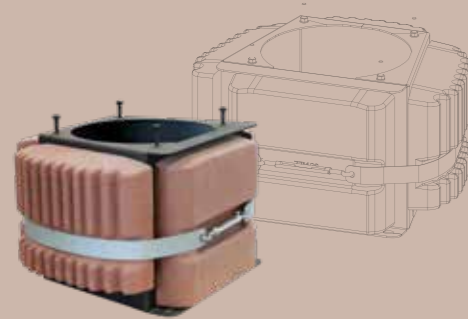

## STORAGE BOX

The storage box is made of steel and is encased in storage mass (patented Heat Memory System) and further enhances the storage capacity. It is installed between the basic body and the flue gas manifold.



## TOP STORAGE RINGS

A simple option to increase the efficiency of the Austroflamm fireplace insert. They are mounted between the main body and flue gas manifold.

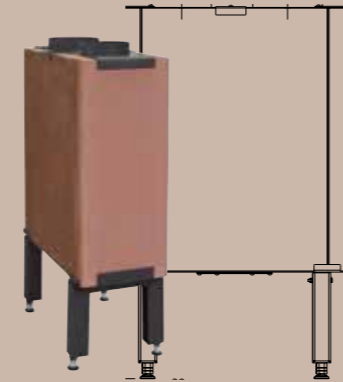

## HEAT RECOVERY UNIT WITH HMS

Maximum energy yield with the Austroflamm heat recovery unit

We *keep*  
 energy *warm*  
 for a long time!



We *are burning*  
for clean air.

#### COMBUSTION TECHNOLOGY

Of course, our appliances are known for their sophisticated design but technology, and above all combustion technology, are equally important to us. With the help of our technicians, we surpass the standards that are imposed on us: emission values for CO, dust, etc. fall well below the threshold values, even those of Level 2 of the Federal Immission Control Ordinance (BImSchV)!

#### THRESHOLD VALUES ACCORDING TO EN 13240 AND DIN PLUS

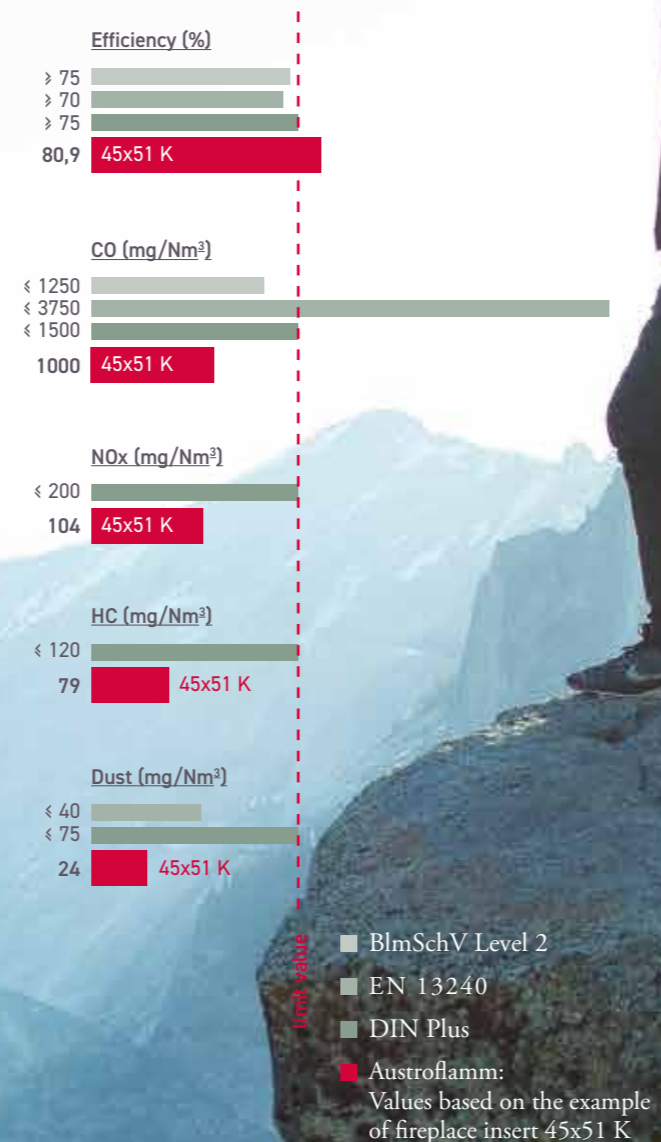

AUSTROFLAMM TECHNOLOGY  
INNOVATIVE  
COMBUSTION  
TECHNOLOGY



45x51 K



# The ap(p)solute in *heating comfort*

## "INSERT CONTROL" FOR REGULATING COMBUSTION

Allow the Insert Control automatic combustion regulator to take over the air control for you. The only control system featuring combustion graphs especially developed for Austroflamm inserts. You can do this from the comfort of your sofa using the APP. Monitor everything with your smartphone (iOS or Android) - that is what we call safety and genuine heating comfort.



INSERT CONTROL  
Concealed in your  
fireplace insert. →

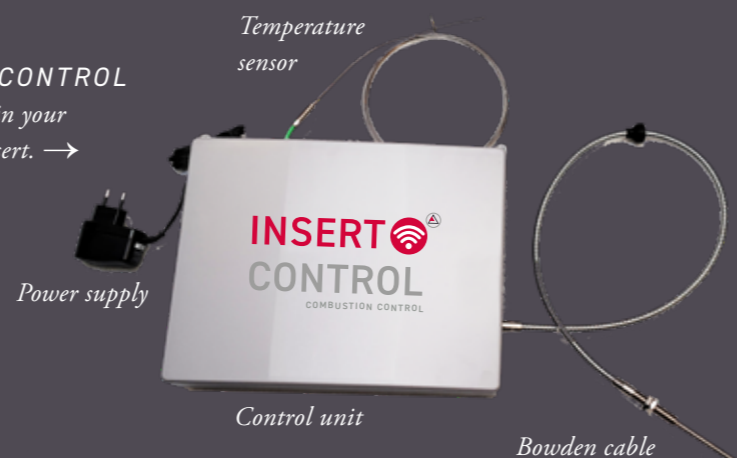

AUSTROFLAMM TECHNOLOGY  
"INSERT CONTROL"  
COMBUSTION REGULATOR  
OPTIONAL ACCESSORY







# FIRE DESIGN

IMPRESSIONS

INSPIRING & FASCINATING  
Your Austroflamm fireplace insert  
lets your imagination run wild.  
Design your own individual fire island.

22

FRONT  
FIREPLACES



30

DESIGN  
FIREPLACES  
ASSEMBLY KIT



34

TUNNEL  
FIREPLACES



38

CORNER  
FIREPLACES



44

3-SIDED  
GLAZED FIREPLACES



50

VUUR DRIE







# FRONT FIREPLACES

A RAVISHINGLY BEAUTIFUL *display of flames!*

*Our master of transformation will melt the heart of anyone who loves a wood fire. Your creative imagination will know no limits. Modern, classic, traditional - install your fireplace insert any way you like.*



97 x 45 S

Left image:  
120 x 45 S





*Naturally beautiful - in every form!*



45 x 68 K



45 x 51 K ROUND

Left image:  
65 X 57 - K 2 . 0





5 5 x 5 7 K



### M Y *fire island*

*A fireplace will conjure up a serene smile on every face. Transform your personally favourite room into an island of peace and tranquillity.*

6 5 x 5 7 S







# TRADITIONAL OR MODERN

*Designing entirely to please myself is music to my ears.  
From a classic country house to a modern city loft -  
with AUSTROFLAMM fireplace inserts, every idea is a success!*







# DESIGN FIREPLACES



## MIU & MIU XTRA DESIGN FIREPLACE / ASSEMBLY KIT

*Stylish variants,  
also available as a tunnel fireplace!*

*Miu Xtra is a tunnel appliance (75x39 K II) with XTRA storage technology.  
Miu is designed as a single-sided fireplace insert and hinged door (75x39 K).  
Both are available as complete sets.*



MIU XTRA MIT 75X39 K





KERA XTRA

**KERA XTRA**  
DESIGN FIREPLACE / ASSEMBLY KIT

*This stylish complete package is available with XTRA storage technology*

*The Kera Xtra 45 is available with hinged door, ceramic set, with or without a wood storage compartment in different ceramic colours and a sophisticated hinged door handle!*

*A real statement piece for any room!*



80 x 64 S



XTRA



45 x 51 K  
KeraXtra





# TUNNEL FIREPLACES

## WE LOVE *fire* PLAY!

*Bright ideas for creative minds - divide, display, feel good - with fireplace inserts from Austroflamm you will never run out of inspiration for your fire.*

*The two-sided tunnel appliance - stylishly integrated into the divisional element - creates a bright spot with a fascinating fire display from two different positions!*



75 x 39 S II

Left image:  
75X51S II 2.0





*Making room for diversity!*



45x57K + 80x64S II

LIVE,  
WORK,  
CREATE.

75x39K II





# C O R N E R FIREPLACES



A BREATH OF FRESH AIR FOR *h e a t i n g*

*Space-saving and perfect for enjoying the fire from two different positions in the room.  
The two-sided fire automatically creates a cosy atmosphere.*



38 x 38 x 57 K



63 x 40 x 42 K



63 X 40 X 51 S 2.0



*A perfectly integrated log compartment!*







89 x 49 x 45 S



89 x 49 x 45 S

*Extremely* F I E R Y  
C O R N E R D I S P L A Y

*Corner fireplaces are the perfect stage for a beautiful wood fire. They are also ideal in their role as a fire island and are suitable for almost any creative setting.*



Right image:

89 x 49 x 57 S



# THREE- SIDED

GLAZED FIREPLACES



WE LIKE TO SHARE OUR *fire!*

*The fireplace insert as a creative design element is a fiery eye-catcher in open-plan room concepts.  
The spectacle of dancing flames is visible from three sides and invites you to while away the hours pleasantly in all areas of the room.*



64 x 33 x 51 S 3

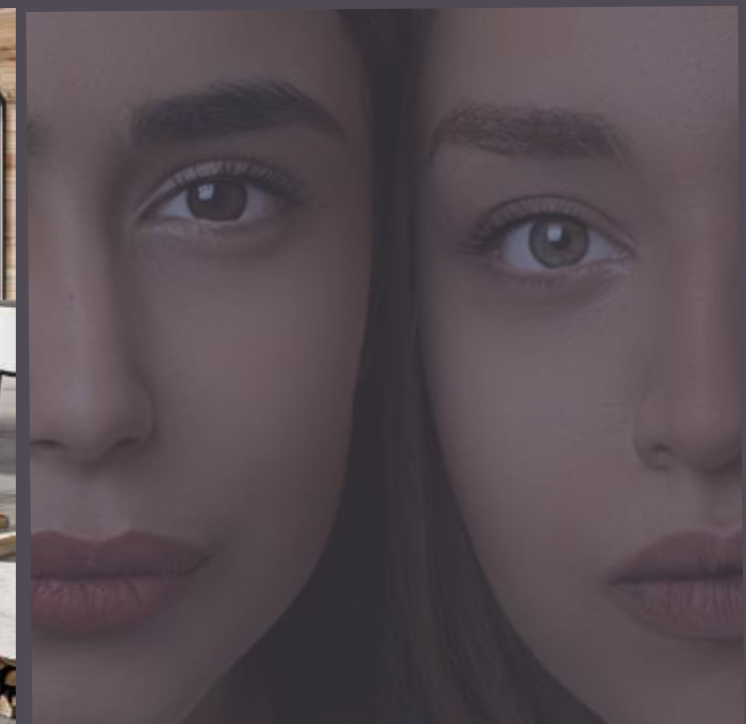

Left image:  
48 x 72 x 51 S 3





4 8 X 7 2 X 5 1 S 3



6 4 x 3 3 x 5 1 S 3

*One of a kind - lastingly beautiful*





48 x 72 x 51 S 3

WE LIKE PLAYING  
WITH *fire!*

*Bringing the fireplace insert into play as a building element is a nice idea for structuring a room. The flickering flames, visible from all three sides, radiate a cosy atmosphere and also provide an elegant feature for your interior design. Thanks to the wide range of dimensions and models available, you will find the perfect fireplace insert whatever the size of the room.*



75 x 35 x 45 S 3



VUUR  
DRIE 60



P E R F E C T - M A T C H  
*f i e r y* & C R E A T I V E

*The VUUR DRIE range from Austroflam featuring a fascinating play of flames on 3 sides is a stage in any room. The elegant black firebox and the particularly slim frame profiles make the fireplace insert a modern designer piece. With a window that can be raised almost completely and a particularly generous firebox aperture, the VUUR DRIE series offers the ultimate in heating comfort. Equipped as standard with a level grate and ember basket, the fireplace insert can also be enhanced with a grilling system. Equipped with proven Austroflam technology, the fireplace insert guarantees clean, low-emission combustion.*



VUUR DRIE 80





# 15 reasons,

for choosing an Austroflamm fireplace insert...

one

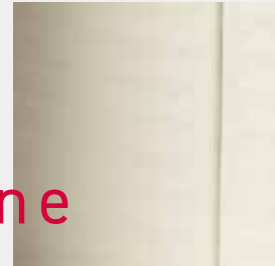

**KERAMOTT:**  
Light-coloured firebox lining, which guarantees clean combustion by means of optimum insulation.

two

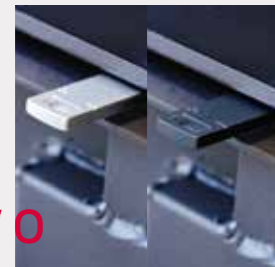

**CONTROL ELEMENTS:**  
Combustion air controls are a distinctive feature designed in matt chrome (black on request), and are safe and easy to operate.

three



**SMOKE COLLECTOR:**  
Manufactured from durable cast iron for many models; all elements can be rotated 360° for easy flue connection.

four



**ADJUSTABLE FEET:**  
Quick, simple and safe to adjust.

five



**WINDOW GLASS:**  
Extremely heat-resistant ceramic glass, reverse printed at the edge. And always of maximum dimensions for a good view of the flames.

six



**OUTSIDE AIR CONNECTION:**  
Combustion air is supplied via a feed pipe which can also be easily routed to the outside. All fireplace inserts are prepared for an outside air connection as standard!

seven



**HEAT STORAGE SYSTEM:**  
Equipped for the installation of heat storage systems, e.g. the patented Heat Memory System. Of course, top-mounted storage units and reheating surfaces can also be connected.

eight

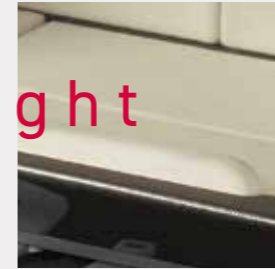

**COMBUSTION AIR FLOW:**  
Crucial for low-emission combustion and clean glass surfaces. Using only one control element, secondary air (glass flushing) and primary air are opened in succession - incorrect operation is impossible!

nine



**DOOR HINGES:**  
On the left as standard, but can easily be changed to the right if desired.

ten



**SELF-LOCKING DOORS:**  
Our hinged doors are not only self-closing, but self-locking too! This not only makes them more convenient to use, but also provides greater safety, which is particularly important when balanced flue operation is required.

eleven



**SLIDING DOOR GUIDES:**  
Extremely quiet and smooth running. Counterweights ensure that they are easy to use.

twelve



**SWIVEL MECHANISM:**  
Sliding doors can also be swung open for cleaning purposes - no tools required!

thirteen



**DOOR HANDLES:**  
Elegant shape, luxurious surface - handles for hinged and sliding doors are available in matt chrome (standard), black, matt chrome with walnut inlay, and black with black wooden inlay.

fourteen



**BLACK KERAMOTT:**  
Some models are also available with black Keramott firebox lining

fifteen



**DIBT-TESTED:**  
Many of our appliances are also certified as tested by the DIBT (GERMAN INSTITUTE FOR STRUCTURAL ENGINEERING)



45 K



45 K ROUND



55 K



65 K



65 S



75 K



## TECHNICAL DATA

Door frame width	450 mm	450 mm	550 mm	650 mm	650 mm	750 mm
Height of door frame	510 / 570 / 680 mm	510	450 / 510 / 570 mm	450 / 510 / 570	510 / 570 mm	390 / 570 mm
Door shapes	straight	round	straight	straight	straight	straight
Hinged doors	standard	standard	standard	standard	-	standard
Sliding doors	-	-	-	-	standard	-

## MASS

Width (installation dimensions of the corpus)	505 mm	483 mm	605 mm	739 mm	739 mm	839 mm
Depth	471 mm	541 mm	471 mm	516 mm	537 mm	516 mm
Height	1245-1445 / 1305-1505 / 1415-1615 mm	1245-1445	1185-1385 / 1245-1445 / 1305-1505 mm	1183-1383 / 1245-1445 / 1305-1505 mm	1245-1445 / 1305-1505 mm	1125-1325 / 1305-1505 mm
Weight	95 / 100 / 110 kg	106	101 / 107 / 112 kg	114 / 120 / 127 kg	168 / 178 kg	118 / 139 kg
Rauchrohrabgang	ø 160 mm	ø 160 mm	ø 160 mm	ø 180 mm	ø 180 mm	ø 180 mm

## OUTPUT

Nominal heat output acc. to EN 13229	6 kW	6 kW	7 kW	8 kW	8 kW	10 kW
Energy efficiency class	A +	A +	A +	A +	A +	A +
Flue gas mass flow	5,14 / 5,2 / 5,2 g/s	5,14	5,85 / 6,01 / 6,17 g/s	7,32 / 7,74 / 6,76 g/s	7,74 / 6,76 g/s	8,13 / 7,7 g/s
Flue gas temperature	354 / 371 / 387 °C	354 °C	275 / 313 / 351 °C	283 / 298 / 317 °C	298 / 317 °C	313 / 330 °C
Min. discharge pressure	12 PA	12 PA	12 PA	12 PA	12 PA	12 PA
Dust emissions	≤ 27 mg/m <sup>3</sup>	≤ 27 mg/m <sup>3</sup>	≤ 39 mg/m <sup>3</sup>	≤ 38 mg/m <sup>3</sup>	≤ 35 mg/m <sup>3</sup>	≤ 40 mg/m <sup>3</sup>
Efficiency rate	80,9 / 80,9 / 80,8 %	80,9 %	82 / 82 / 80,1 %	80,6 / 80,5 / 80 %	81 / 80 %	81,9 / 82 %

75 S



80x64 S



97 S



120x45 S



45 K II



## TECHNICAL DATA

Door frame width	750 mm	800 mm	970 mm	1200 mm	450 mm
Height of door frame	390 / 570 mm	640 mm	450 / 740 mm	450 mm	510 mm
Door shapes	straight	straight	straight	straight	straight
Hinged doors	-	-	-	-	standard
Sliding doors	standard	standard	standard	standard	-

## MASS

Width (installation dimensions of the corpus)	839 mm	1044 mm	1214 mm	1444 mm	473 mm
Depth	537 mm	550 mm	550 mm	550 mm	600 mm
Height	1125-1325 / 1339-1539 mm	1360-1560 mm	1170-1370 / 1460-1660 mm	1170-1370 mm	1243-1443
Weight	161 / 194 kg	280 kg	272 / 340 kg	316 kg	124 kg
Rauchrohrabgang	ø 180 mm	ø 180 mm	ø 180 mm	ø 180 mm	ø 160 mm

## OUTPUT

Nominal heat output acc. to EN 13229	10 kW	10 kW	11 / 12 kW	13 kW	6 kW
Energy efficiency class	A +	A +	A +	A +	A +
Flue gas mass flow	8,13 / 7,7 g/s	8,28 g/s	9,96 / 9,9 g/s	14,88 g/s	5,52 g/s
Flue gas temperature	313 / 300 °C	312 °C	274 / 288 °C	254 °C	292 °C
Min. discharge pressure	12 PA	12 PA	12 PA	12 PA	12 PA
Dust emissions	≤ 40 mg/m <sup>3</sup>	≤ 24 mg/m <sup>3</sup>	≤ 26 mg/m <sup>3</sup>	≤ 30 mg/m <sup>3</sup>	≤ 23 mg/m <sup>3</sup>
Efficiency rate	82 %	80,5 %	80,2 / 80,1 %	81 %	80,2 %

75x39 K II



75 S II



80x64 S II



38x38x57 K



55X55X..K



## TECHNICAL DATA

Door frame width	750 mm	750 mm	800 mm	380 mm	550 mm
Height of door frame	390 mm	390 / 510 mm	640 mm	570 mm	510 / 570 / 680 mm
Door shapes	straight	straight	straight	corner 90°	corner 90°
Hinged doors	standard	-	-	standard	standard
Sliding doors	-	standard	standard	-	-

## MASS

Width (installation dimensions of the corpus)	773 mm	848 mm	1044 mm	409 mm	579 mm
Depth	511 mm	527 mm	565 mm	409 mm	579 mm
Height	1124-1324 mm	1123-1323 mm / 1284-1484 mm	1360-1560 mm	1093-1293 mm	1230-1430 / 1290-1490 / 1400-1600 mm
Weight	130 kg	186 / 202 kg	269 kg	72 kg	105 / 109 / 117 kg
Rauchrohrabgang	ø 180 mm	ø 180 mm	ø 180 mm	ø 150 mm	ø 180 mm

## OUTPUT

Nominal heat output acc. to EN 13229	10 kW	10 / 12 kW	10 kW	5 kW	7 kW
Energy efficiency class	A +	A +	A +	A +	A
Flue gas mass flow	7,26 g/s	7,3 / 13,07 g/s	8,43 g/s	5 g/s	7,5 g/s
Flue gas temperature	331 °C	331 / 252 °C	291 °C	273 °C	330 °C
Min. discharge pressure	12 PA	12 / 13 PA	12 PA	12 PA	14 PA
Dust emissions	18 mg/m <sup>3</sup>	≤ 30 mg/m <sup>3</sup>	≤ 21 mg/m <sup>3</sup>	≤ 20 mg/m <sup>3</sup>	≤ 40 mg/m <sup>3</sup>
Efficiency rate	82 %	82 / 81 %	80,4 %	82 %	78,9 %

63x40x42 K



63x40x42 S



63x40x51 S



69x49x57 S



## TECHNICAL DATA

Door frame width	630 mm	630 mm	630 mm	690 mm
Height of door frame	420 mm	420 mm	510 mm	570 mm
Door shapes	corner 90°	corner 90°	corner 90° left / right	corner 90° left / right
Hinged doors	standard	-	-	-
Sliding doors	-	standard	standard	standard

## MASS

Width (installation dimensions of the corpus)	675 mm	720 mm	720 mm	780 mm
Depth	445 mm	490 mm	490 mm	580 mm
Height	1137-1337 mm	1137-1337 mm	1359-1559 mm	1384-1584 mm
Weight	126 kg	169 kg	185 kg	231 kg
Rauchrohrabgang	ø 150 mm	ø 150 mm	ø 150 mm	ø 180 mm

## OUTPUT

Nominal heat output acc. to EN 13229	8 kW	8 kW	12 kW	12 kW
Energy efficiency class	A +	A +	A +	A +
Flue gas mass flow	7,65g/s	7,65 g/s	12 g/s	12,42 g/s
Flue gas temperature	230 °C	230 °C	283 °C	260 °C
Min. discharge pressure	10 PA	10 PA	10 PA	12 PA
Dust emissions	30 mg/m <sup>3</sup>	30 mg/m <sup>3</sup>	27 mg/m <sup>3</sup>	≤ 29 mg/m <sup>3</sup>
Efficiency rate	82 %	82 %	81,6 %	82 %



89x49x.. S



48x51x51 S3



48x72x51 S3



64x33x51 S3



## TECHNICAL DATA

Door frame width	890 mm	480 mm	480 mm	640 mm
Height of door frame	450 / 570 mm	510 mm	510 mm	510 mm
Door shapes	corner 90° left / right	3-sided	3-sided	3-sided
Hinged doors	-	-	-	-
Sliding doors	standard	standard	standard	standard

## MASS

Width (installation dimensions of the corpus)	977 mm	496 mm	496 mm	656 mm
Depth	568 mm	629 mm	839 mm	449 mm
Height	1209-1409 / 1389-1589 mm	1376-1514 mm	1376-1514 mm	1371-1509 mm
Weight	216 / 222 kg	202 kg	254 kg	199 kg
Rauchrohrabgang	ø 180 mm	ø 180 mm	ø 180 mm	ø 150 mm

## OUTPUT

Nominal heat output acc. to EN 13229	12 kW	10 kW	15 kW	10 kW
Energy efficiency class	A +	A +	A +	A +
Flue gas mass flow	10,84 / 10,2 g/s	11,96 g/s	17,32 g/s	11,86 g/s
Flue gas temperature	297 / 307 °C	270 °C	270 °C	261 °C
Min. discharge pressure	12 PA	12 PA	12 PA	12 PA
Dust emissions	≤ 26 mg/m³	≤ 25 mg/m³	≤ 30 mg/m³	≤ 29 mg/m³
Efficiency rate	80 %	82 %	80 %	80 %

75x35x45 S3



65x51 K



VUUR DRIE 60



VUUR DRIE 80



## TECHNICAL DATA

Door frame width	750 mm	650 mm	635 mm	835 mm
Height of door frame	450 mm	510 mm	510 mm	570 mm
Door shapes	3-sided	straight	3-sided	3-sided
Hinged doors	-	standard	-	-
Sliding doors	standard	-	standard	standard

## MASS

Width (installation dimensions of the corpus)	786 mm	704 mm	635 mm	835 mm
Depth	469 mm	494 mm	592 mm	592 mm
Height	1252-1390 mm	1254-1454 mm	1347-1397 mm	1467-1517 mm
Weight	218 kg	202 kg	230 kg	312 kg
Rauchrohrabgang	ø 150 mm	ø 180 mm	ø 180 mm	ø 180 mm

## OUTPUT

Nominal heat output acc. to EN 13229	10 kW	12 (75%) kW	12 kW	15 kW
Energy efficiency class	A +	A +	A +	A +
Flue gas mass flow	11,49 g/s	12 g/s	11,4 g/s	14,8 g/s
Flue gas temperature	263 °C	265 °C	276 °C	254 °C
Min. discharge pressure	12 PA	12 PA	12 PA	12 PA
Dust emissions	≤ 30 mg/m³	24 mg/m³	28 mg/m³	28 mg/m³
Efficiency rate	80 %	82 %	≥ 80 %	≥ 80 %

## NEW COMER &amp; DESIGN FIREPLACE

**NEW! BAKING COMPARTMENT**  
for fireplace inserts

Baking compartment



**MIU 75 WITH HINGED DOOR (TUNNEL)**  
Design fireplace / assembly kit



**MIU XTRA 75 WITH HINGED DOOR**  
Design fireplace / assembly kit



**KERA XTRA 45 WITH HINGED DOOR**  
Design fireplace / assembly kit



## TECHNICAL DATA

Door frame width	-	-	-	-
Height of door frame	-	-	-	-
Door shapes	straight	-	-	-
Hinged doors	standard	standard	standard	standard
Sliding doors	-	-	-	-

## MASS

Width	550 mm	1820 mm	1820 mm	680 (1020) mm
Depth	466 mm	511 mm	570 mm	600 mm
Height	353 mm	1620 mm	1620 mm	1600 mm
Weight	52,3 kg	1001 kg	1078 kg	340 kg
Flue pipe outlet	depending on KE (Dm160 bzw. Dm180)	ø 180 mm	ø 180 mm	ø 160 mm

## OUTPUT

Nominal heat output acc. to EN 13229	-	10 kW	10 kW	6 kW
Energy efficiency class	-	A +	A +	A +
Flue gas mass flow	-	8,1 g/s	8,1 g/s	5,9 g/s
Flue gas temperature	-	313 °C	313 °C	354 °C
Min. discharge pressure	-	12 PA	12 PA	14 Pa
Dust emissions	-	36 mg/Nm³ (13% O2)	28 mg/Nm³ (13% O2)	24 mg/Nm³ (13% O2)
Efficiency rate	-	80,9 %	81,9 %	80,9 %

AVAILABLE FOR fireplace insert models:  
45x51K, 45x57K, 45x68K, 55x45K,  
55x51K, 55x57K, 65x45K, 65x51K,  
65x57K, 75x39K, 75x57K

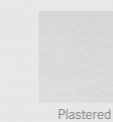

Plastered

## ACCESSORIES MIU &amp; MIU XTRA::

- Fire table left / right
- Grate with ash box
- Flat hinged-door handle matt chrome/brown, black wood/black wood (optional), black (optional)
- Black air regulator (optional)



Plastered

## ACCESSORIES KERA XTRA:

- Wood storage compartment, can be fitted on the left or right side
- Ceramic set for Kera with and without wood storage compartment
- KE short ash box + grate (45 - 55)
- Flat hinged-door handle matt chrome/brown wood (optional), black/black wood (optional), black (optional)
- Black air regulator (optional)







*Notes*

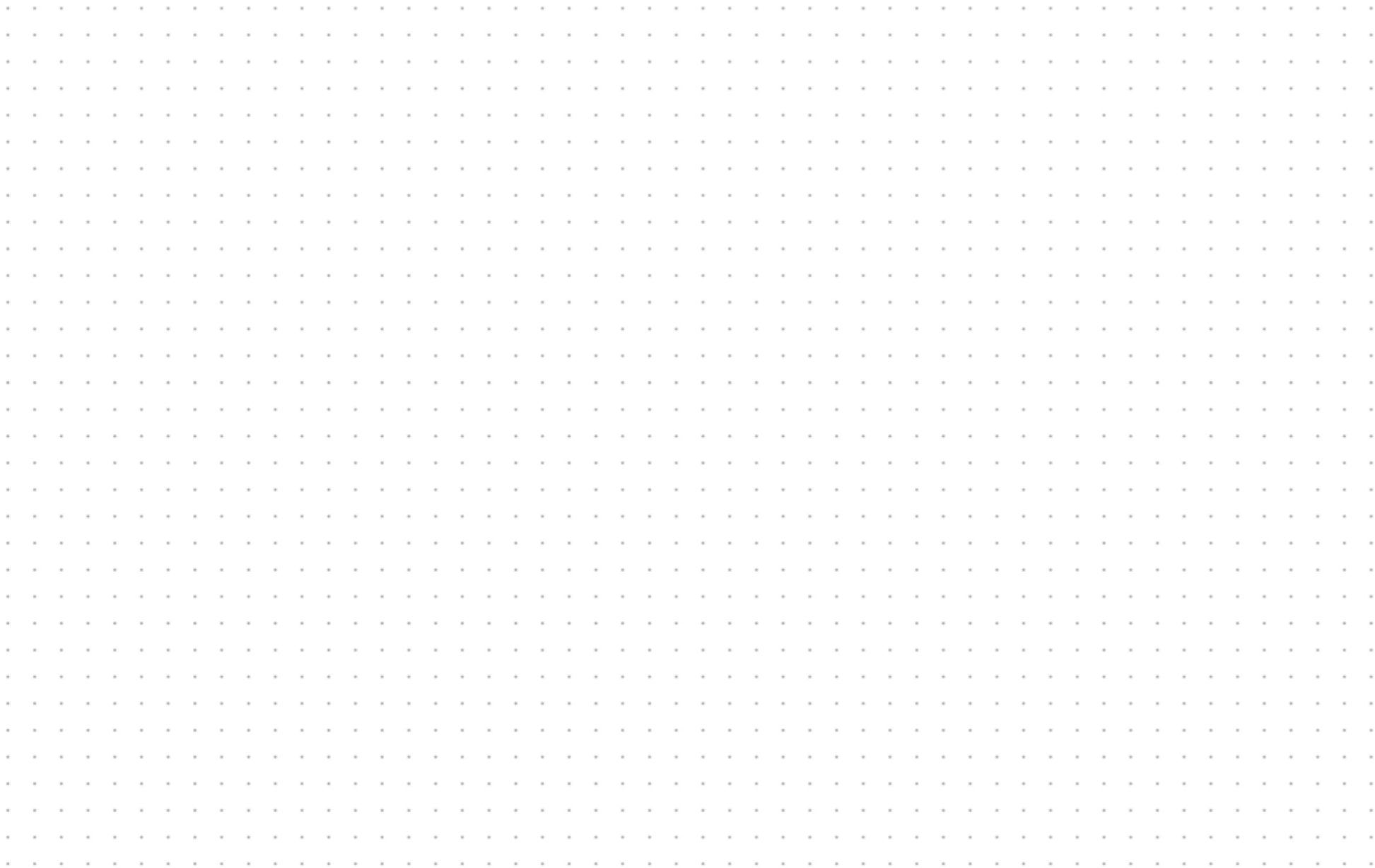

We reserve the right to make technical and visual modifications without prior notice and do not accept liability for errors in composition or printing.



MAGICAL *fire* THAT  
WILL TAKE YOU BY STORM!

Whether it's blowing a gale or snowing, you will always be on the safe (weather) side with a fireplace as the focal point of your home! We take the wind out of the sails of the energy crisis and heat economically, efficiently and in comfort. More information for "Fireplace inserts with flair" at [www.austroflamm.com](http://www.austroflamm.com)





AUSTROFLAMM

Austroflamm fireplace inserts are sold worldwide through specialist retailers. Please visit our homepage for further information.  
AUSTROFLAMM GmbH / Austroflamm-Platz 1, A-4631 Krenglbach / T: +43 7249 46443-0, info@austroflamm.com / [www.austroflamm.com](http://www.austroflamm.com)

