

hoxter

Fireplace inserts  
Water heating fireplace inserts

2017

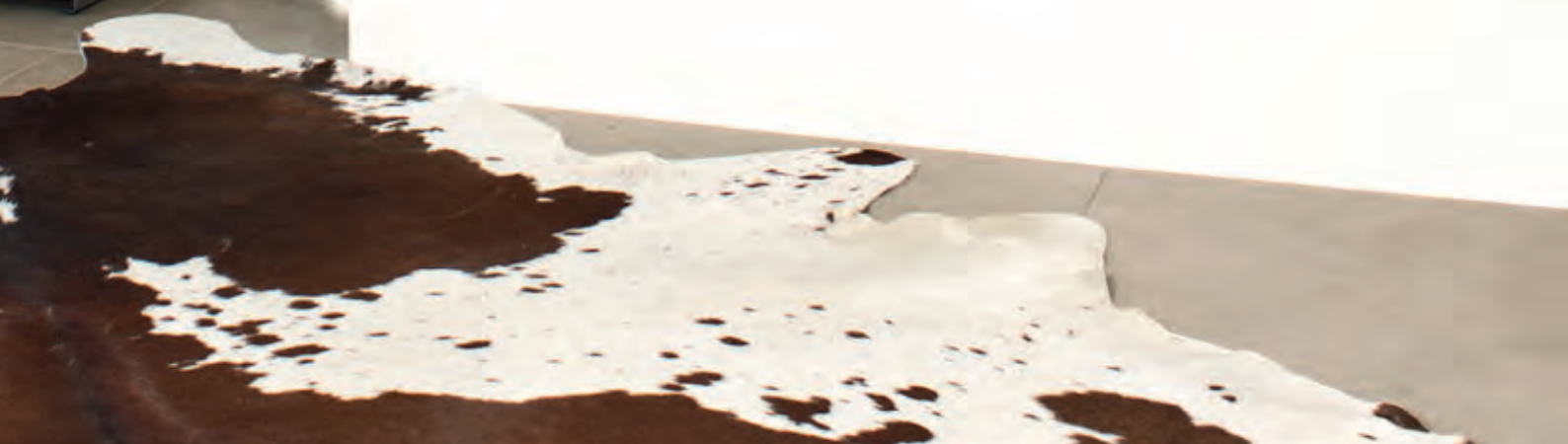

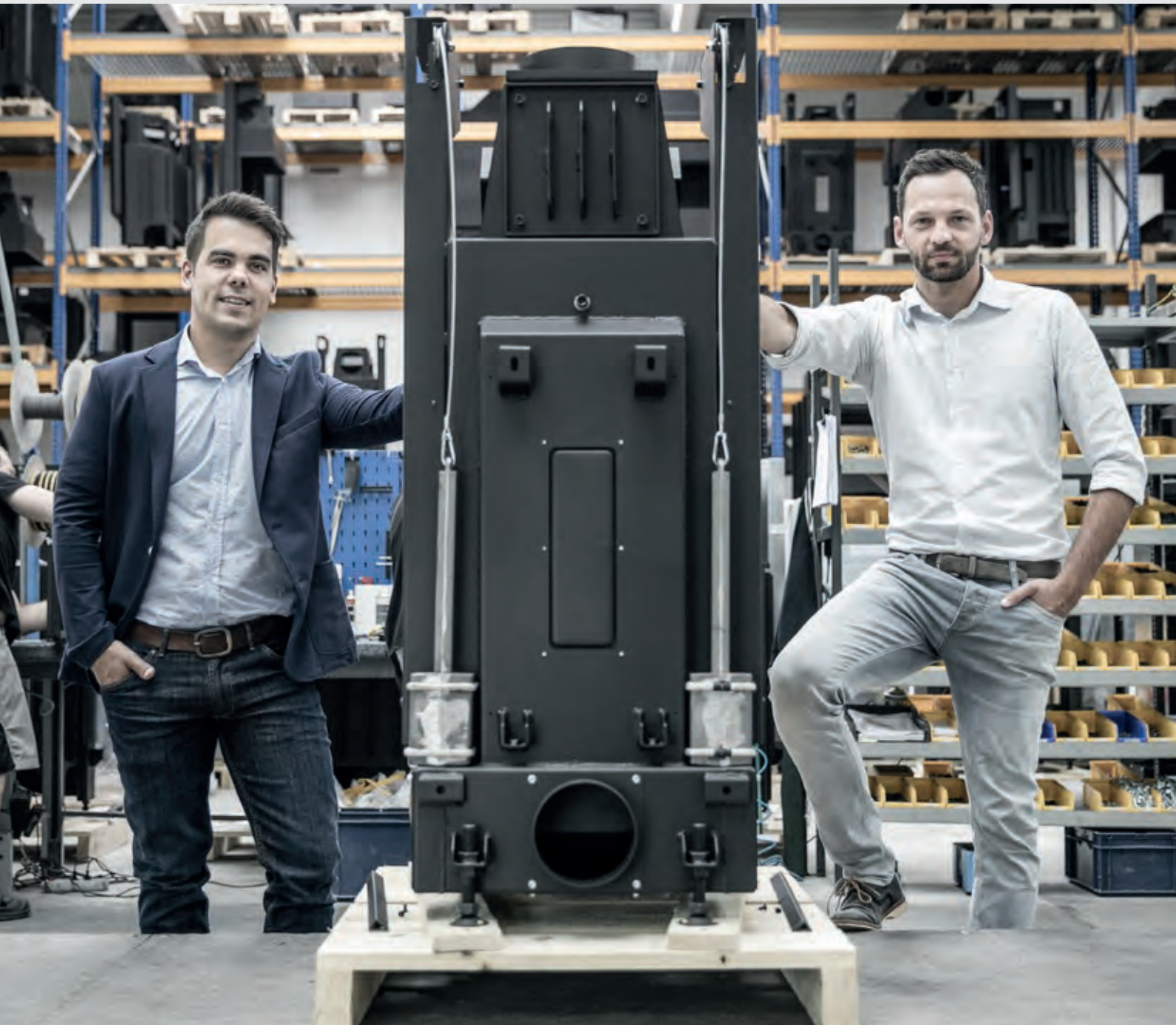



We work under the motto: „*We don't want to be the biggest, but the best and most popular.*“

Since 2009 Hoxter product are sold in 22 countries in Europe and we can say: „*What we do, we understand.*“

**Richard Dorazil, Petr Banasinski**

Founders of Hoxter



# Content

## Technology

- 06–09 First class operating system
- 10–13 Double glass
- 14–15 Comfort of clean glass
- 16–17 Frames
- 18–19 Door design
- 20–21 Removable handle
- 22–23 Lining of the combustion chamber
- 24–25 Rear feeding

## Products

- 26–43 Fireplace inserts
  - 44–51 Water heating fireplace inserts
  - 52–49 Electronic combustion control
- 
- 54–57 Hoxter company

# First class operating system

Operation of the Hoxter products is as clear as their stove glass. Thanks to this, daily attendance like feeding firewood and controlling the fire, will become a new passion.



Spiral door handle





## Mechanism of liftdoors

A sophisticated slide mechanism guarantees a permanent quiet and light movement of the door. The door slides in a closed chamber over the door and does not restrict the living room in this way. The precise movement of the door at high operating temperatures is guaranteed by eight bearings which are resistant up to a temperature of 350 °C. These bearings move in stainless steel profiles which guide the door movement exactly and permanently. By opening the sliding door it automatically draws out by several millimeters thereby increasing the longevity of the fire cord seals. A spring mechanism presses the door closed into locking position by force of 25 kg and thereby air tightens the firebox perfectly.







## Easy to operate

The fireboxes of the HOXTER products are so tight that the fire immediately responds to ever so little a movement of the control lever. High combustion temperature in the firebox does not affect the safety and control comfort. Control elements are designed to be self-cooling during the operation. This cooling effect is amplified by using suitable materials as stainless steel. Next to design, Hoxter paid much attention to simplicity of control. They are characterized by pure shapes and intuitive control.



## Complete combustion creating less waste

The grateless firebox provides the user several important advantages. The fuel in the grateless firebox burns down to fly ash and therefore releases maximum thermal energy. The volume of ash produced is reduced to practically nothing because of complete combustion, greatly reducing cleaning intervals. Some remaining ashes on the firebox floor will aid to complete combustion of the next fire, keeping your stove glass clear which is a delight to the user.





## Double glazing

### More intensive enjoyment of fire without overheating the room

The double glazed doors corresponds to current building standards. Energy requirements of houses as well as individual rooms are lower than ever thanks to modern standards of the thermal house insulation. The double glazing improves the insulation qualities of the door and reduces the heat amount radiated to the room through the door. The room with lower energy requirements is not overheated in this way.

The double glass is a standard feature for all water heating products and storage heater doors. The double glazed version is optional for the fireplace inserts and corner water-bearing fireplace inserts.

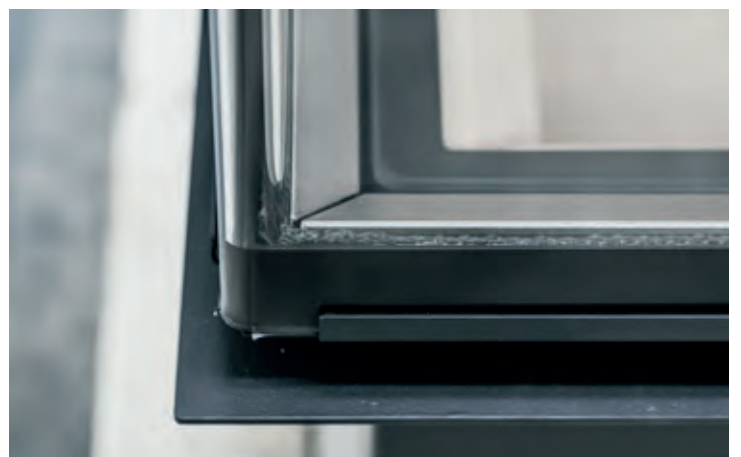



## Reinforced door profile

The door is a much used moving part where strength and stability are of utmost importance. These qualities are fulfilled by a specially made door profile with the wall thickness of 2.5 mm. The parameter of the door profile strength guarantees stability of the door mechanics in the daily operation at high temperatures. The doors can be ordered in single and double glazing. The seals in the door profile are mounted in a conical groove which holds it in place.

## Corner door with double glass

Double glazing in the corner doors sets an example of innovation applied as standard. A more effective combination of design and pragmatism can hardly be conceived. The inner corner glazing is mounted in the door frame in dilatation seams that allow for thermal expansion at high combustion temperatures. Both glass panes are bent in the corner to close the space between them and protect it from penetration of impurities. This innovative solution extends possibilities to choose the right type of glazing also for rooms with lower energy requirements.



## Higher combustion temperatures in the firebox

The double glazing provides a better insulation capacity and thereby increases average firebox combustion temperature by 120 °C. \* It affects the combustion quality positively and enables to use the heat more effectively.

\* The stated values were measured at the model ECKA 67/45/51W with the fuel batches of 6 kg + 4 kg.

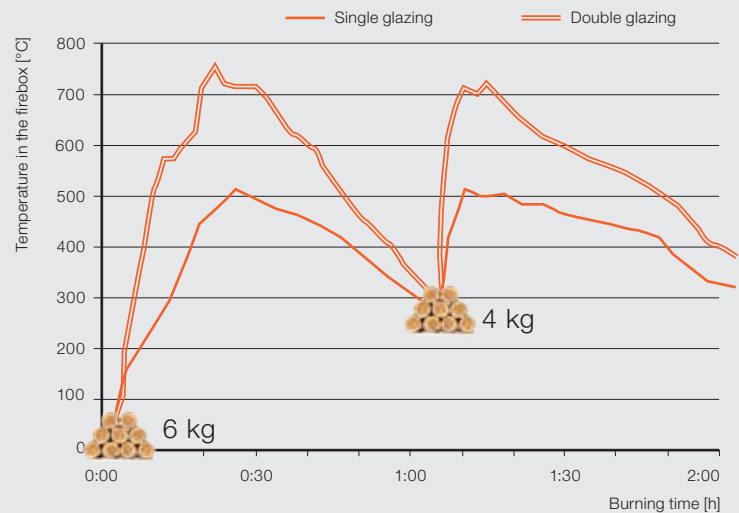

# Comfort of clean glass

## The comfort of self cleaning fireplace glass

Self cleaning fireplace glazing has a high priority while developing the products HOXTER. The combustion air flow system is designed to lead the air-flow along the fireplace glazing. This air wash creates a dynamic air screen that circulates black combustion particles back into the firebox. The clearness of the fireplace glazing will also be greatly affected by the humidity of the firewood, chimney draught or the way you control the air intake to your fireplace.

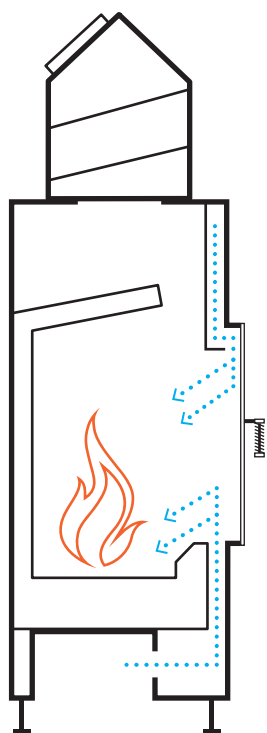

### Supply of external combustion air

The combustion air needed to supply HOXTER products flows in the fireplace through a central air supply. The air in the living room will not be affected by the combustion process.

The primary air supply in the lower part of the firebox provides extra air for initial combustion.

The secondary air supply above the door increases combustion efficiency and keeps the glass clean. The level of adjustment for both air supplies can be done accordingly to requirements and conditions.









# Frames

The full glass fireplace door has a hidden frame providing a generous view of the fire. The cover and built-on frames are an aesthetic addition to the fireplace insert when build into its fireplace surround. Their detailed workmanship and material quality enhance the value and design of the completed fireplace.

Cover frame 2 x 45°



Cover frame 1 x 90°



Cover frame 1 x 90° (ECKA)



Build-on frame 50 mm

# Door design

The door handle is available in black or stainless steel finish, with a classic spiral or modern flat shape. For liftdoor models we offer the removable handle with practical casing. Double sided and rear fed models can be equipped with an elegant "invisible" handle which is hidden between door and the door frame.

Outer glass of the doors may be attached with standard black door bars or with bars made from polished stainless steel. When the stainless steel option is used not only the product stands out but it highlights also the details made from fine materials.



Flat door handle







## Removable handle

The removable door handle allows to create a natural undistracted view to the flames. This handle may be used on all products with liftdoors. There is a small rectangle opening bottom side of the door where the handle may be easily placed. The opening is placed near the center of gravity of the door. Thanks to this the easy operation of the liftdoors system is guaranteed. After the doors are closed the handle may stay on the doors or may be removed and stored into an installed casing.



## Practical and elegant casing for the removable handle

The removable handle is made from a stainless steel. Practical casing which may be installed into the fireplace wall offers an elegant solution where the removable handle may be stored. The visible parts of the casing are made from stainless steel as well so it creates together with the removable handle a harmonical design solution. The handle itself has its place and it doesn't interfere with the interior.

# Lining of the combustion chamber

The company Hoxter offers not only the standard light lining, but also the dark lining option is available. This solution is primarily suitable for interiors where the light lining would affect distraction. Shaped parts of the lining are made from colored fireclay mixture. This means, that the visual appearance of the combustion chamber remains colour-stable even when the surface of the lining is accidentally damaged. Fireclay shaped parts of both light and dark shade are burned during the production with temperature of 1100 °C. Thanks to this process the long lifespan of the whole combustion chamber is guaranteed.



Light lining (standard) | Dark lining

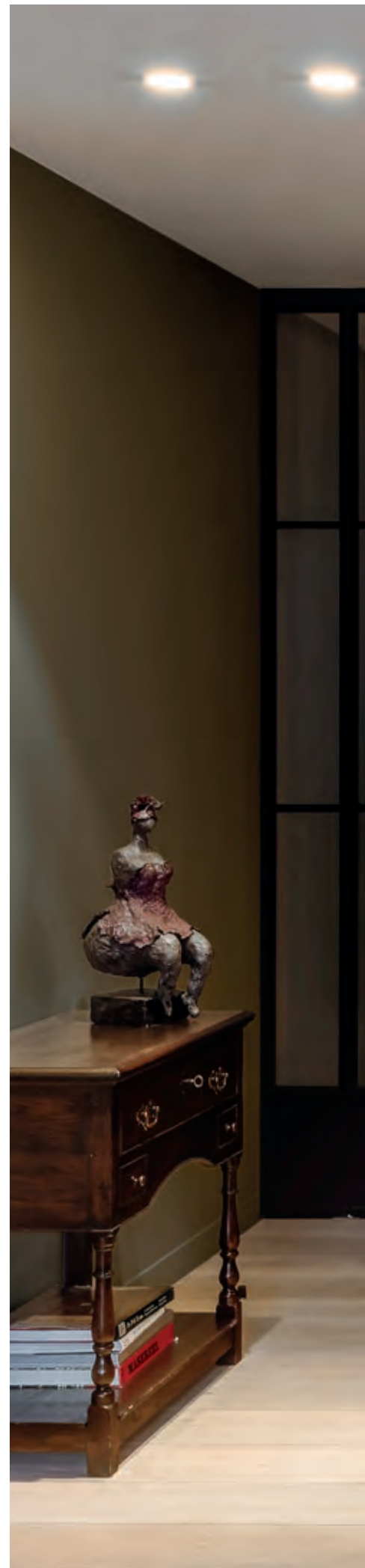



# Rear feeding

## Clean solution for your living space

The advantage of a rear feeding door is a practical and clean contribution. The fireplace glass door offers a spectacular view of the fire in the living room while the rear door without glass is used to feed the furnace from a utility room or a hallway. The door for the rear feeding is designed not to be visible from the front side of the fireplace. Nevertheless its presence does not reduce a high combustion efficiency and cleanness of the fireplace glazing.

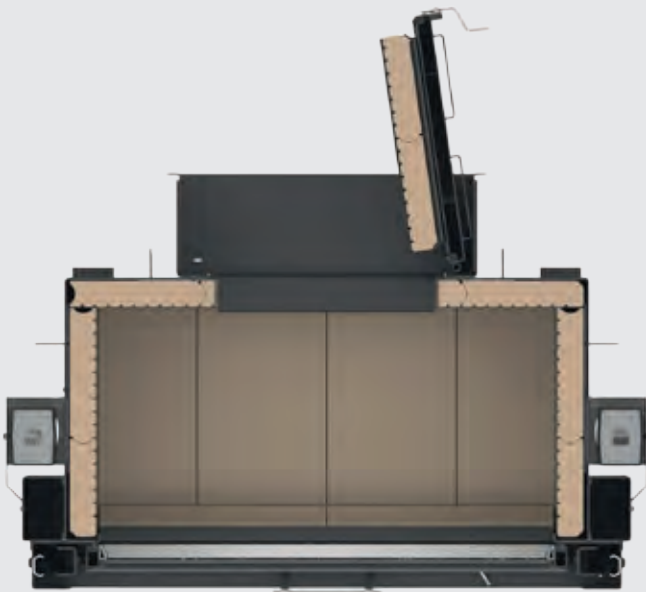
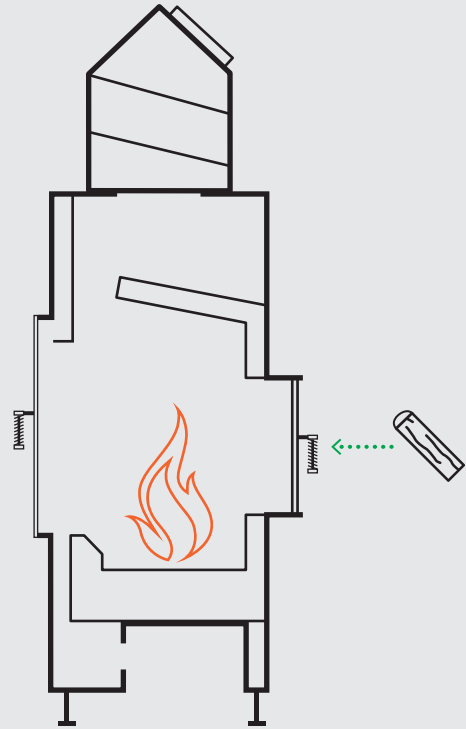

Some of HOXTER fireplace inserts can be also equipped with rear feeding doors. The inner side of the rear door is lined with fireclay or Nyrolit concrete. Size of the door is large enough to allow stoking of 33 cm logs.





# Fireplace inserts

## Heating will become your new passion

Storage, mass storage and convection fireplaces are the most required ways of heating nowadays. The fireplace inserts from Hoxter conform with both technologies. They work perfectly well in the enclosed surrounds of the storage fireplaces with the additional storage mass. They are also adapted to the operation in the convection air fireplaces where they offer a possibility to the hot air distribution in other rooms.





## Storage fireplace

The heat storage fireplace offers heat accumulation and healthy radiant heat. The hourly heat output with this type of fireplace is lower and the fueling interval is longer. Hot combustion gas from the firebox flow to the attached heat storage mass that can be put on top or next to the fireplace insert. This heat storage mass is a heavy fire clay, heat resistant and absorbing flue duct that stores the heat from the combustion fumes. While burning and afterwards the stored radiant heat is slowly released into the living area.

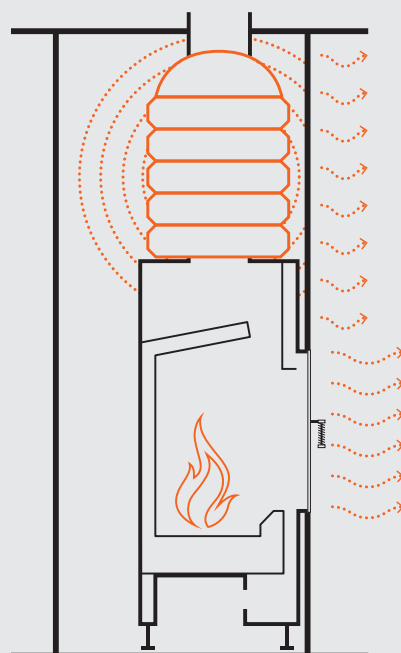
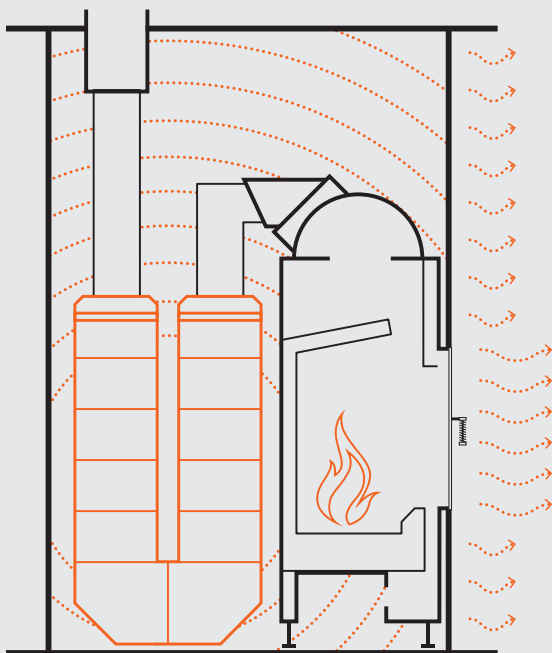



Additional mass storage significantly increases the heat capacity of the fireplace. Energy stored in 150 kg of HOXTER accumulation rings offers a radiant heat source for many hours after the last fueling. Double layer construction and special inner spiral shape of the rings perfectly conducts the heat from combustion fumes to the mass storage. Simple solution requiring no further power source.

## Convection air fireplace

The convection fireplace is an ideal solution where the room or house has to be heated up as quick as possible. Hot burning gas passes the heat through an air heat exchanger on top of the fire place insert on to the ambient air. The heated air flows through ventilation grills into the room where the fireplace is situated or it is distributed through the air-heating system to other rooms. Cold air is sucked inside the lower part of the fireplace encasement through a grill where the air is heated again by the air heat exchanger.

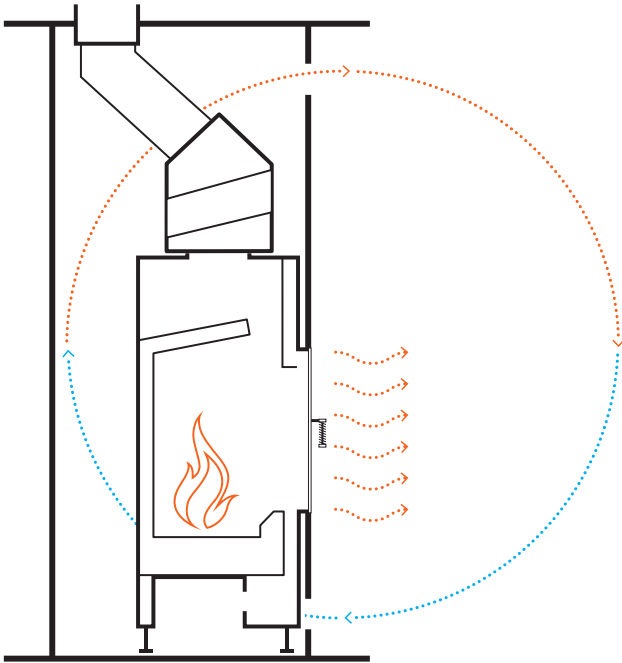

## Convection air distribution

Plenty of heat arises in the hot-air fireplace. Efficiency of its use is increased by a hot-air jacket. The additional hot-air jacket to the fireplace inserts of HOXTER is used as a hot air collector around the fireplace inserts. The hot air can be distributed to other rooms by means of hot air ducts throughout the building. Also by means of a double glazed door, the heat output in the room the fireplace is installed in can be greatly reduced if required.





HAKA 63/51

# Flat glass



## HAKA 37/50

Output capacity connected to the chimney  
**5–12 kW**

Amount of firewood per heating cycle  
**4,5 kg**

Compatible with:  
accumulation rings

Ratio heat distribution



## HAKA 37/50G

(Deep chamber)

Output capacity connected to the chimney  
**6–16 kW**

Amount of firewood per heating cycle  
**6 kg**

Compatible with:  
accumulation rings

Ratio heat distribution



## HAKA 37/50GN

(Deep chamber with secondary burning chamber)

Output capacity connected to the chimney  
**6–16 kW**

Amount of firewood per heating cycle  
**8 kg**

Compatible with:  
accumulation rings

Ratio heat distribution



## HAKA 63/51

Output capacity connected to the chimney  
**6–16 kW**

Amount of firewood per heating cycle  
**6 kg**

Compatible with:  
accumulation rings, rear feeding

Ratio heat distribution



## HAKA 67/51h

Output capacity connected to the chimney  
**6–16 kW**

Amount of firewood per heating cycle  
**5,5 kg**

Compatible with:  
accumulation rings

Ratio heat distribution



## HAKA 78/57(h)

Output capacity connected to the chimney  
**6–16 kW**

Amount of firewood per heating cycle  
**5,5 kg**

Compatible with:  
accumulation rings, rear feeding

Ratio heat distribution







### HAKA 89/45h

Output capacity connected to the chimney  
**8–16 kW**

Amount of firewood per heating cycle  
**5,5 kg**

Compatible with:  
 rear feeding

Ratio heat distribution



### HAKA 89/72h

Output capacity connected to the chimney  
**9–18 kW**

Amount of firewood per heating cycle  
**5,5 kg**

Ratio heat distribution



### HAKA 110/51h

Output capacity connected to the chimney  
**9–18 kW**

Ratio heat distribution



### HAKA 150/51h

Output capacity connected to the chimney  
**10–20 kW**

Ratio heat distribution









# Tunnel



**HAKA 37/50T**

Output capacity connected to the chimney  
**6–16 kW**

Amount of firewood per heating cycle  
**6 kg**

Compatible with:  
accumulation rings

Ratio heat distribution



**HAKA 63/51T**

Output capacity connected to the chimney  
**6–16 kW**

Amount of firewood per heating cycle  
**6 kg**

Compatible with:  
accumulation rings

Ratio heat distribution



**HAKA 78/57T(h)**

Output capacity connected to the chimney  
**6–16 kW**

Amount of firewood per heating cycle  
**6 kg**

Compatible with:  
accumulation rings

Ratio heat distribution



**HAKA 89/45T(h)**

Output capacity connected to the chimney  
**8–16 kW**

Ratio heat distribution



**HAKA 110/51Th**

Output capacity connected to the chimney  
**9–18 kW**

Ratio heat distribution



# Corner glass



## ECKA 50/35/45(h)

Output capacity connected to the chimney  
**5–12 kW**

Amount of firewood per heating cycle  
**4,5 kg**



## ECKA 51/51/51(h)

Output capacity connected to the chimney  
**5–13 kW**

Amount of firewood per heating cycle  
**5,0 kg**

Compatible with:  
accumulation rings



## ECKA 67/45/51(h)

Output capacity connected to the chimney  
**6–16 kW**

Amount of firewood per heating cycle  
**5,5 kg**

Compatible with:  
accumulation rings, rear feeding



## ECKA 76/45/57h

Output capacity connected to the chimney  
**6–16 kW**

Amount of firewood per heating cycle  
**5,5 kg**

Compatible with:  
accumulation rings, rear feeding



## ECKA 90/40/40h

Output capacity connected to the chimney  
**8–16 kW**

Amount of firewood per heating cycle  
**5 kg**

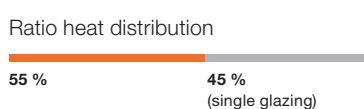

- Fireplace insert (+ attached storage mass)
- Door glass (double glazing)

The technical data and drawings are to be found on our homepage [www.hoxter.de](http://www.hoxter.de)







## Three side glass



UKA **37/55/37/57h**

Output capacity connected to the chimney  
**6–12 kW**

Amount of firewood per heating cycle  
**4 kg**

Ratio heat distribution



UKA **37/75/37/57h**

Output capacity connected to the chimney  
**8–14 kW**

Amount of firewood per heating cycle  
**4,5 kg**

Ratio heat distribution



UKA **37/95/37/57h**

Output capacity connected to the chimney  
**9–17 kW**

Amount of firewood per heating cycle  
**5 kg**

Ratio heat distribution



UKA **69/48/69/51h**

Output capacity connected to the chimney  
**6–12 kW**

Ratio heat distribution

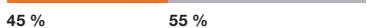

The technical data and drawings are to be found on our homepage [www.hoxter.de](http://www.hoxter.de)

■ Fireplace insert (+ attached storage mass)  
■ Door glass (double glazing)







EOKA 67/45/51Wh



## Water heating fireplace inserts

Heating your whole house while having  
a magnificent view of the fire

Water heating fireplace inserts provide an unique feeling by the visual impact of the fire and the efficient heat transfer to the domestic water at the same time. The water heating fireplace inserts meet the modern requirements to high volume hot water supply. Thanks to this system the room where the fireplace is situated not overheated and the Water heating fireplace assures heating of the whole house as well as the domestic water heating. The water heating fireplace inserts in combination with the storage tank offer a profitable heat accumulation system.

## Water heating fireplace

The water heating fireplace provides a heat source to heat the whole house and the domestic hot tap water supply. Hot combusting fumes pass through the water heat exchanger on top of the fireplace insert. The water from the hot-water exchanger heats up to 70–80 °C and flows from the water heating fireplace insert to a storage tank. The heat is stored in the storage tank and can be used to heat radiators, underfloor heating and domestic hot tap water supply.

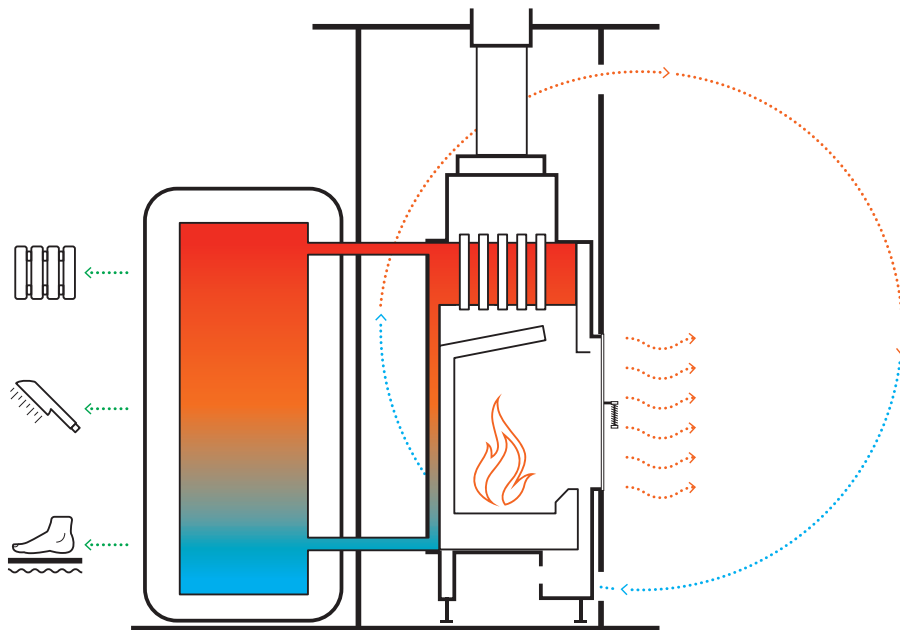



## Your fireplace as a boiler

Technical capabilities of the water heating fireplace inserts from HOXTER meet the requirement of a state of the art modern heating system. The value and the efficiency of the hot water production are comparable to wood gasification boilers. The standard double door glazing reduces the heat transmission through the glass in a significant way and it helps increase the hot-water output ratio in this way. The hot-water exchanger assures a maximum efficiency. It absorbs up to 70 % of the heat from the burning cycle. The hot-water exchanger also absorbs some heat through the firebox walls. Thermal insulation is another improvement preventing the heat to escape from the water heating fireplace inserts. This technical solution improved the hot-water ratio to 80 %.

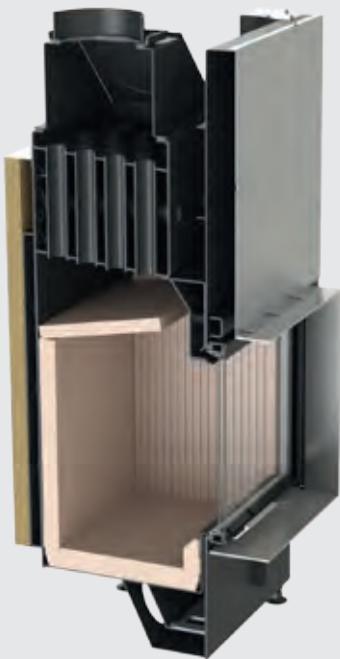

## Safe operation

A multistage security device takes care of the safe operation of HOXTER water heating inserts. An integrated cooling system protects the hot-water exchanger against overheating in case of a power cut. When the water temperature in the exchanger exceeds 95 °C, the valve opens and feeds water from the cold water supply system in the integrated stainless steel cooling spiral and cools down the boiler. A pressure valve is another safety device which reduces the over pressure in the hot-water exchanger automatically below 2.5 bar.

# Flat glass



**HAKA 37/50WI**

Output capacity connected to the chimney  
**5–10 kW**

Ratio heat distribution



**HAKA 63/51WI**

Output capacity connected to the chimney  
**10–24 kW**

Ratio heat distribution



**HAKA 63/51Wa**

Output capacity connected to the chimney  
**10–24 kW**

Ratio heat distribution



**HAKA 67/51Wh**

Output capacity connected to the chimney  
**8–22 kW**

Ratio heat distribution



**HAKA 78/57W(h)**

Output capacity connected to the chimney  
**10–24 kW**

Ratio heat distribution



**HAKA 89/45Wh**

Output capacity connected to the chimney  
**10–24 kW**

Ratio heat distribution



The technical data and drawings are to be found on our homepage [www.hoxter.de](http://www.hoxter.de)

- Hot-water exchanger
- Fireplace insert
- Door glass (double glazing)



# Tunnel



HAKA **63/51WT**

Output capacity connected to the chimney  
**10–19 kW**

Ratio heat distribution



HAKA **78/57WT(h)**

Output capacity connected to the chimney  
**10–22 kW**

Ratio heat distribution



HAKA **89/45WT(h)**

Output capacity connected to the chimney  
**10–22 kW**

Ratio heat distribution





EOKA 67/45/51Wh



## Corner glass



### ECKA 50/35/45W(h)

Output capacity connected to the chimney  
**5–12 kW**

Ratio heat distribution



### ECKA 67/45/51W(h)

Output capacity connected to the chimney  
**8–17 kW**

Ratio heat distribution



- Hot-water exchanger
- Fireplace insert
- Door glass (double glazing)

# Electronic combustion control ABRA 6.1

The automatic combustion control registers the current phase of burning process and controls the accurate feeding of the air to get as much energy from the wood as possible. After the fuel is completely burned down the air flap is fully closed. This ensures the maximum efficiency of the fuel energy and minimal losses.

The technical innovation meets modern design and practical solutions: mobility of the display, non mechanical contact of components, easy operation and robustness of the individual components.

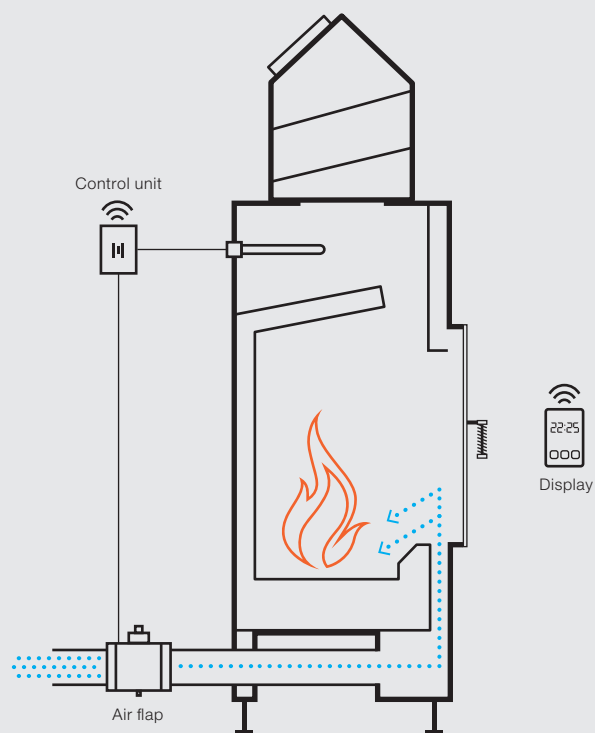

## Display

The display and control unit communicates wirelessly. That means you can take the display anywhere in the house and have all the relevant information about the fireplace in your hand.



## New control unit and door contact

The body of the control unit is made of aluminium. The contactless door sensor is magnetic so there is no need for any moving parts. This solution is completely maintenance-free since therefore avoiding mechanical failure.



## Robust air flap

The new air flap is made of 1 mm stainless steel. The SIEMENS engine controls the position of the air flap via the control unit. In case of power failure the spring automatically fully opens the flap. In case of service intervention the engine can be dismantled easily.

# Hoxter company

## The best technologies starts with detail

Even the smallest part has its own exact place and function. We create high-quality products thanks to the high quality of materials used and high value human labour. We focus on the needs of the user and a detailed technical performance. Therefore the HOXTER products meet the highest quality standards and offer a maximum user comfort.





## Hoxter customer service

We fully back our products and we are there for you when you need us. All service requests will be completed within a few days. The customer service is operated directly from the factory by our qualified technicians who know the products inside out.

All service access is located inside the body of the fireplace allowing all important parts to be completely servicable from inside the burning chamber. There is no need for extra revision openings or covers.



## Your confidence is our obligation

We take full responsibility for our products. You can rely on our technical support and service in case of purchasing a new product or repairing a used one. We can help you to choose a suitable product and heating solution for your house. Our trade network is created by trained stove builder-specialists providing a complex full service and delivering high standard installation of heat fireplaces and stoves.





## We understand what we do

Closely working together with skilled craftsmen and long experience in the development and design of the fireplace and stove technology, makes us real specialists. The high standards we have set ourselves today, challenge us for future innovations. Thanks to this we can consider our products to be the best ones. We are proud that our innovative solutions contribute to the technological development in the whole fireplace and stove industry.





**HOXTER GmbH**

Hersbrucker Straße 23  
91244 Reichenschwand  
GERMANY  
Tel.: +49 (0)9151 8659 163  
E-mail: info@hoxter.de

**HOXTER a.s.**

Blanenska 1902  
66434 Kurim  
CZECH REPUBLIC  
Tel.: +420 518 777 701  
E-mail: info@hoxter.eu

**[www.hoxter.de](http://www.hoxter.de)**

**VERSION 04/2017**

**EN-M1000102**

Changes of the stated data and errors reserved.

The technical data and drawings are to be found on our homepage **[www.hoxter.de](http://www.hoxter.de)**

